



**INSERTS FOR TURNING**

**MIQOR**  
tools



**A BRAND  
NEW  
BRAND**

LSAB Group has long and solid experience of the market's need for cutting tools for the wood and metal industry. We are now broadening our offering with our own brand and selected products.

### OUR FIRST PRODUCTS

We have decided to look for quality and affordable products. And we find them, because we know what makes a difference. First out, we launch a wide range of ISO turning inserts. That range has passed the eye of the needle in terms of price and quality.



### VALUABLE AND SMART TOOLS

The product price is based on performance and quality, not on brand. As for the quality of the product, it is neither too low nor too high, because you do not want to pay for something you do not need. We take part in the development, take advantage of innovations and improvements that make a difference in your production costs.

A handwritten signature in black ink, appearing to read 'Hans Ekholm', is positioned above the name and title.

HANS EKHOLM  
MIQORTOOLS







## PRICE EXAMPLES INSERTS FOR TURNING

ART.NR.	ARTICLE DESCRIPTION	PRICE
CCMT09T304MU P25C	Turning insert CVD: Medium U~	45,50
CNMG120408FU P25C	Turning insert CVD: Finishin~	55,30
DCMT11T304MU P25C	Turning insert CVD: Medium U~	51,10
DNMG110404MRU P25C	Turning insert CVD: Roughing~	56,00
DNMG150608MM PMS25P	Turning insert PVD: Medium SS	70,70
SNMG120408MRU P25CX	Turning insert CVD: Roughing~	60,90
TCMT110204MRU P25C	Turning insert CVD: Roughing~	41,30
TNMG160408MM PMS25P	Turning insert PVD: Medium SS	51,80
VCMT110304MRU P25C	Turning insert CVD: Roughing~	51,10
WNMG060408MRU P25C	Turning insert CVD: Roughing~	51,80

ALL PRICES IN SEK. WITH RESERVATION FOR POSSIBLE CHANGES AND ERRORS IN THIS CATALOGUE.

# OVERVIEW SINGLE SIDED INSERTS

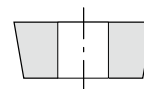



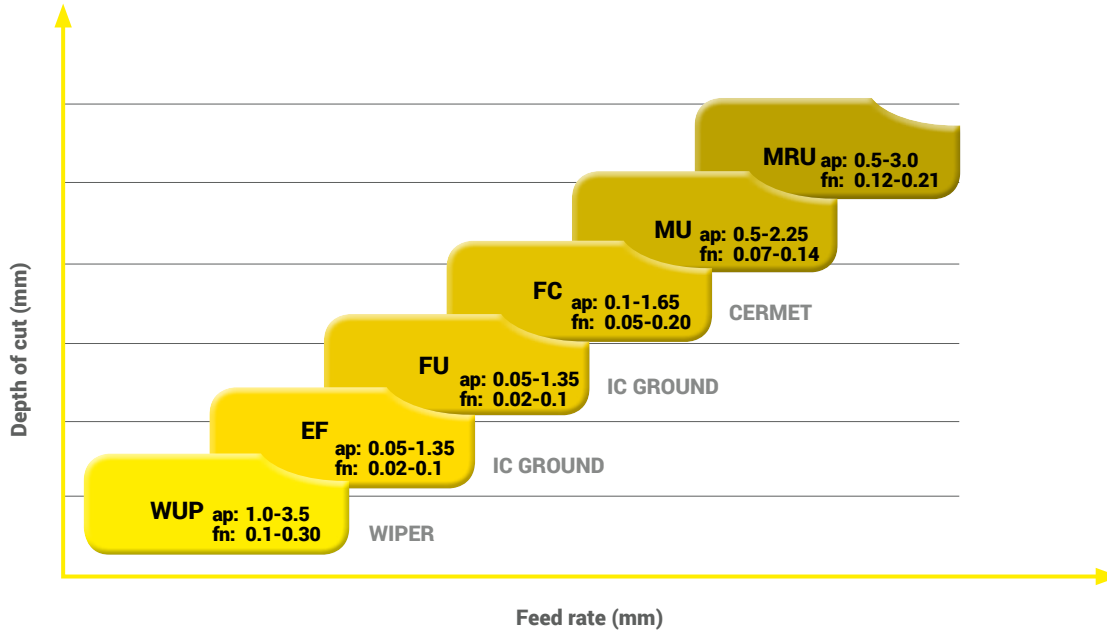
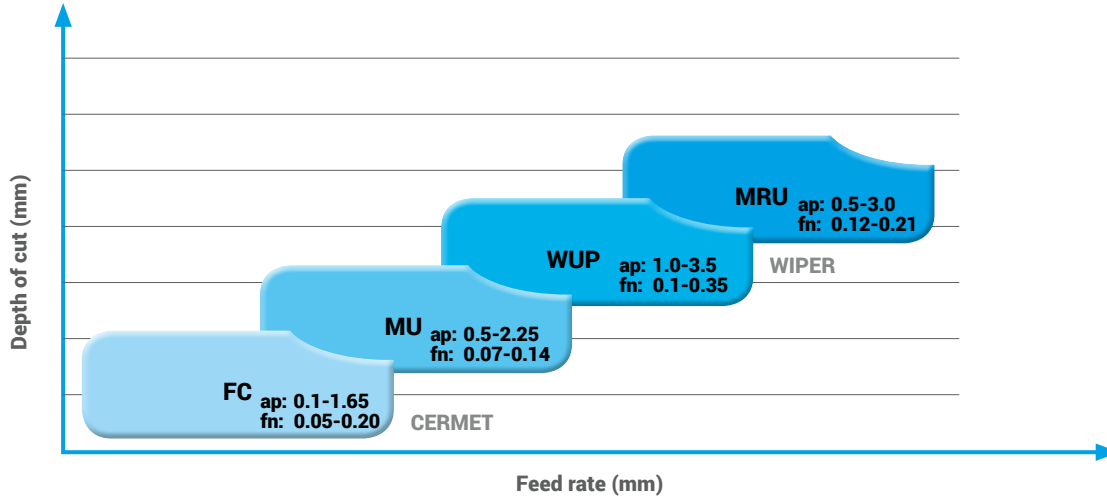



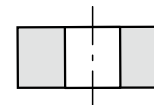



	Steel extreme finishing	WIPER	▼▼▼	WUP P 26
	Steel finishing	CERMET	▼▼▼	FC P 28
	Steel finishing		▼▼▼	MU P 30
	Steel semi finishing		▼▼	MRU P 36
	Stainless steel extreme finishing	WIPER	▼▼▼	WUP P 42
	Stainless steel extreme finishing	IC GROUND	▼▼▼	EF P 44
	Stainless steel finishing	IC GROUND	▼▼▼	FU P 46
	Stainless steel finishing	CERMET	▼▼▼	FC P 48
	Stainless steel finishing		▼▼▼	MU P 50
	Stainless steel medium		▼▼	MRU P 52
	Cast iron		▼▼	MRU P 56
	Non-ferrous semi finishing medium	IC GROUND	▼▼	FU P 58







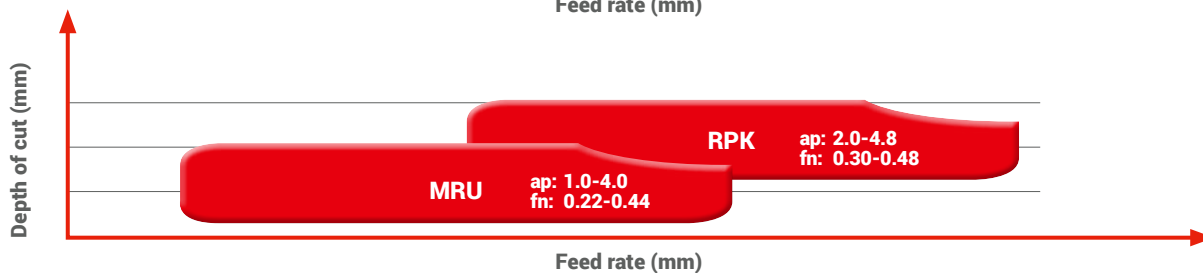
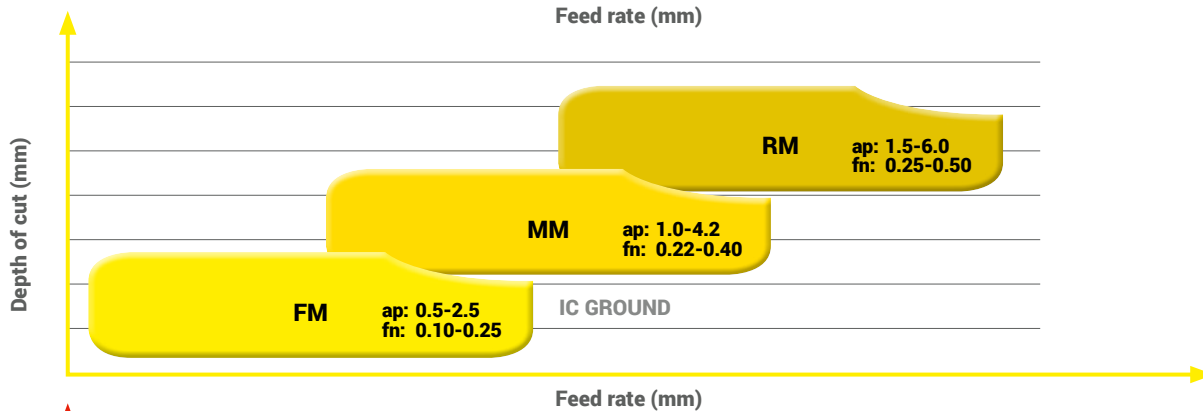
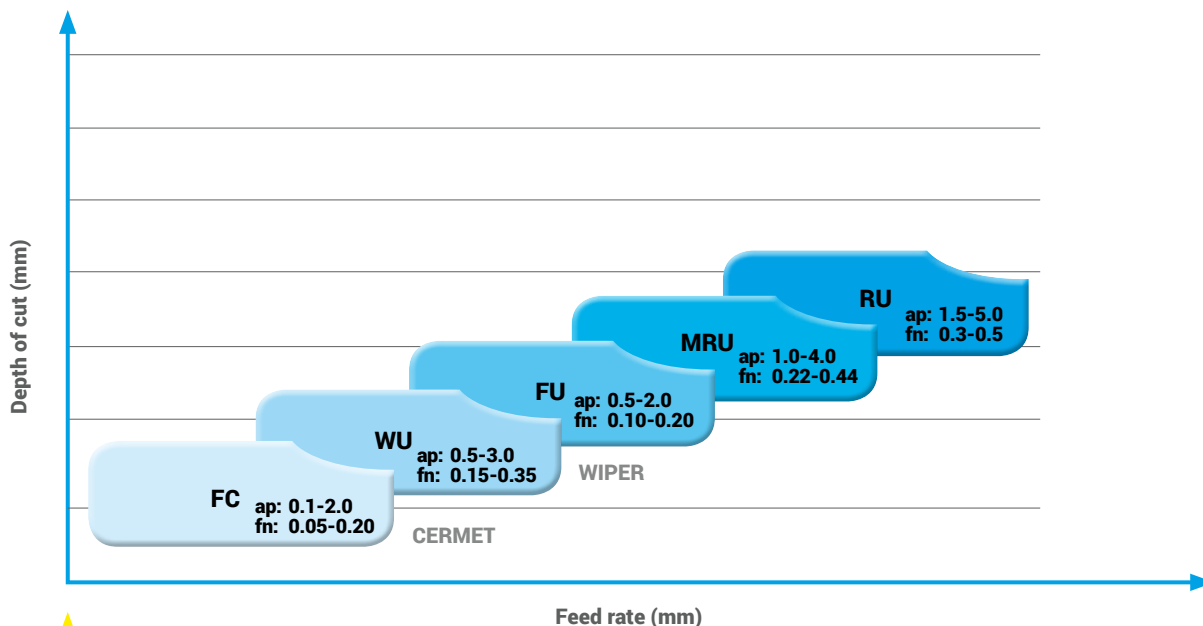

# OVERVIEW DOUBLE SIDED INSERTS



	Steel extreme finishing	WIPER	▼▼▼	WU P 62
	Steel semi finishing	CERMET	▼▼▼	FC P 64
	Steel semi finishing		▼▼▼	FU P 66
	Steel semi finishing		▼▼	MRU P 68
	Steel roughing		▼	RU P 76
	Stainless steel finishing	IC GROUND	▼▼▼	FM P 78
	Stainless steel medium		▼▼	MM P 80
	Stainless steel roughing		▼	RM P 84
	Cast iron medium		▼▼	MRU P 86
	Cast iron light roughing		▼	RPK P 88
	Exotics semi finishing		▼▼	FS P 92



## OVERVIEW HDT – HEAVY DUTY TURNING







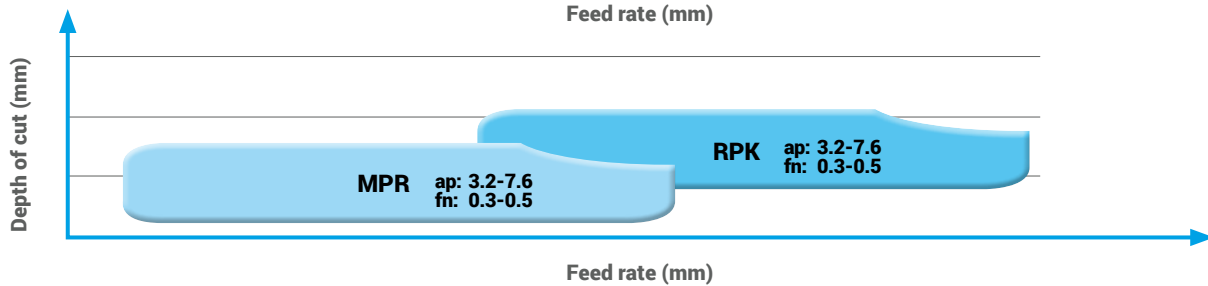
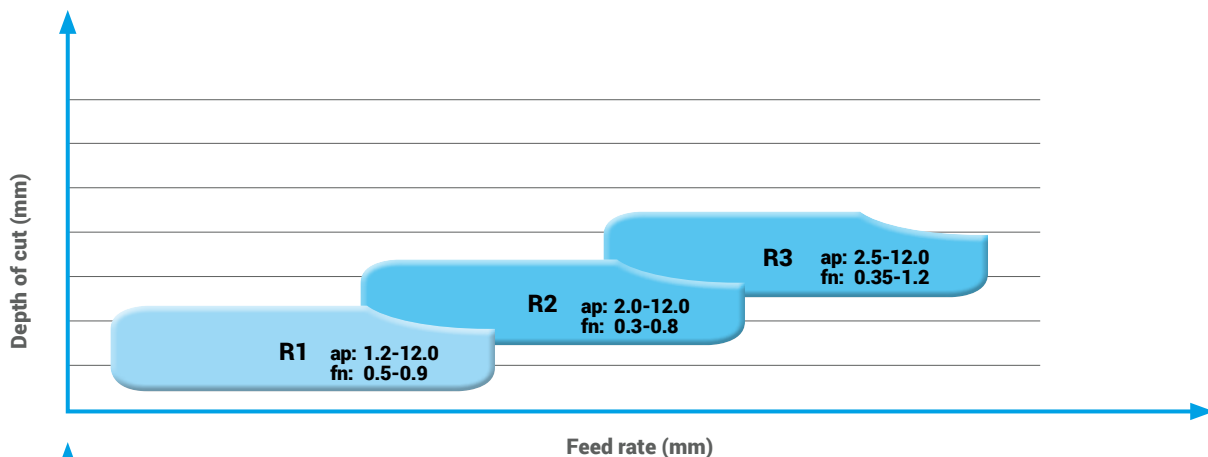



	Steel tube chamfering	▼▼	STC P 98
	Steel roughing	▼	R1 P 100
	Steel roughing	▼	R2 P 102
	Steel heavy roughing	▼	R3 P 104
	Steel medium	▼▼	RPK P 106
	Steel roughing	▼	RPK / MPR P 108 (RCMT only)
	Cast iron roughing	▼	RPK P 110

## MISCELLANEOUS

	Steel medium	▼▼	MP P 114
---	--------------	----	----------





## OVERVIEW PCBN







	Geometry C	CCGW	<b>P 124</b>
	Geometry C	CNGA	<b>P 125</b>
	Geometry D	DCGW	<b>P 126</b>
	Geometry D	DNGA	<b>P 127</b>
	Geometry S	SCGW	<b>P 128</b>
	Geometry S	SNGA	<b>P 128</b>
	Geometry T	TCGW	<b>P 129</b>
	Geometry T	TNGA	<b>P 129</b>
	Geometry V	VCGW	<b>P 130</b>
	Geometry V	VNGA	<b>P 130</b>
	Geometry W	WNGA	<b>P 131</b>



# OVERVIEW PCD

	Geometry C	CCGW	<b>P 132</b>
	Geometry C	CPGW	<b>P 132</b>
	Geometry C	CCGT	<b>P 132</b>
	Geometry C	CPGT	<b>P 132</b>
	Geometry C	CCGW	<b>P 133</b>
	Geometry C	CCGT	<b>P 133</b>
	Geometry D	DCGW	<b>P 134</b>
	Geometry D	DCGT	<b>P 134</b>
	Geometry S	SCGW	<b>P 135</b>
	Geometry S	SCGT	<b>P 135</b>
	Geometry T	TCGW	<b>P 136</b>
	Geometry T	TCGT	<b>P 137</b>
	Geometry V	VCGW	<b>P 138</b>
	Geometry V	VCGT	<b>P 138</b>

## OVERVIEW CVD

	Geometry C	CCGW	<b>P 139</b>
	Geometry C	CCGT	<b>P 140</b>
	Geometry C	CPGW	<b>P 141</b>
	Geometry C	CPGT	<b>P 141</b>
	Geometry D	DCGW	<b>P 142</b>
	Geometry D	DCGT	<b>P 142</b>
	Geometry S	SCGW	<b>P 143</b>
	Geometry S	SCGT	<b>P 143</b>
	Geometry T	TCGW	<b>P 144</b>
	Geometry T	TCGT	<b>P 145</b>
	Geometry V	VCGW	<b>P 146</b>
	Geometry V	VCGT	<b>P 146</b>



# DESIGNATION SYSTEM ISO/CBN/PCD INSERTS

**C N M G 12 04 08 FM**

1	2	3	4	5	6	7	8
---	---	---	---	---	---	---	---

**P M H 10 T**

14	15	16	17
----	----	----	----

**C N G A 12 04 08 SR 02020 MT 3**

1	2	3	4	5	6	7	9.10	11	12	13
---	---	---	---	---	---	---	------	----	----	----

**H - - 10 CBN**

14	15	16	17
----	----	----	----

**1**

**Insert shape**

Included angle	35°	V
	55°	D
	75°	E
	80°	C
	86°	M
Included angle	55°	K
	82°	B
	85°	A
Other shapes	90°	L
	108°	P
	120°	H
	135°	O
	-	R
	90°	S
	60°	T
80°	W	

**2**

**Clearance angle**

3°	A	25°	F
5°	B	30°	G
7°	C	0°	N
15°	D	11°	P
20°	E		

**3**

**Tolerances**

	$d \pm$ (mm)	$m \pm$ (mm)	$s \pm$ (mm)
A	0,025	0,005	0,025
F	0,013	0,005	0,025
C	0,025	0,013	0,025
H	0,013	0,013	0,025
E	0,025	0,025	0,025
G	0,025	0,025	0,13
J	0,05-0,015*	0,005	0,025
K	0,05-0,015*	0,013	0,025
L	0,05-0,015*	0,025	0,025
M	0,05-0,015*	0,05-0,2*	0,13
N	0,05-0,015*	0,05-0,2*	0,025
U	0,08-0,25*	0,13-0,38*	0,13

\*depends on insert size

**4**

**Form of topsurface**

N		
R		
F		
A		
M,P		
G,P		
W		
T		
Q		
U		
B		
H		
C		
J		
X	Special version	

**9**

**Cutting edge**

F		sharp
E		honed
T		chamfered
S		chamfered and honed
K		double chamfered
P		double chamfered & honed

**10**

**Cutting direction**

**11**

**Chamfertype**

	width (mm)	angle °
015	0,15	05
020	0,20	10
025	0,25	15
050	0,50	20
075	0,75	25
100	1,00	30

**12**

**Number of cuttingedges**

ST		Single tip
MT		Multi tip
DMT		Double sided multitip

**13**

**Length of segment**

\*approximate dimension in mm

5

### Cutting edge length

Typ	ISO	L (mm)	d (mm)	Typ	ISO	L (mm)	d (mm)
C 	06	6,4	6,35	T 	06	6,9	3,97
	09	9,7	9,525		09	9,6	5,56
	12	12,9	12,7		11	11,0	6,35
	16	16,1	15,875		16	16,5	9,525
	19	19,3	19,05		22	22,0	12,7
	25	25,8	25,4		27	27,5	15,875
S 	32	32,24	31,75	33	33,0	19,05	
	06	6,35	6,35	W 	06	6,5	9,525
	09	9,525	9,525	08	8,7	12,7	
	12	12,7	12,7	10	10,9	15,875	
	15	15,875	15,875	06	6,35	6,35	
	19	19,05	19,05	08	8,00	8,00	
D 	25	25,4	25,4	9	9,52	9,52	
	31	31,75	31,75	10	10,0	10,0	
	07	7,7	6,35	12	12,0	12,0	
	11	11,6	9,525	12*	12,7	12,7	
	15	15,5	12,7	15	15,875	15,875	
	11	11,1	6,35	16	16,0	16,0	
R 	16	16,6	9,525	19	19,05	19,05	
	22	22,1	12,7	25	25,0	25,0	
				25*	25,4	25,4	
				31	31,75	31,75	
				32	32,00	32,00	

6

### Insert thickness

Index	(mm)
01	1,59
02	2,38
03	3,18
T3	3,97
04	4,76
05	5,56
06	6,35
07	7,94
09	9,52

7

### Corner radius

Index	
00	≤0,05
01	0,1
02	0,2
04	0,4
06	0,6
08	0,8
12	1,2
16	1,6
24	2,4
32	3,2

8

### Geometry

EF	Excellent Finishing
FC	Finishing Cermat
FU	Finishing Universal
FM	Finishing Stainless Steel
WUP	Wiper Universal Positive
WU	Wiper Universal
MU	Medium Universal
MM	Medium Stainless Steel
MRU	Medium Roughing Universal
RU	Roughing Universal
RM	Roughing Stainless Steel
RPK	Roughing Steel Castiron
MPR	Medium Steel Round
R1	Roughing 1
R2	Roughing 2
R3	Roughing 3

14

### Primary workpiece material

P	Steel
M	Stainless Steel
K	Cast Iron
N	Non-ferrous
S	High-Temp Alloys
H	Hardened Materials

15

### Secondary workpiece material (optional)

16

### Application Range

HARDEST	5	Fine Finishing
	10	Finishing
	15	
20	Medium	
25		
30		
TOUGHEST	35	Roughing
	40	
	45	Heavy roughing
	50	

17

### Insert Material

P	PVD-coated carbide
C	CVD-coated carbide
T	Cermet
CBN	CBN
PCBN	Coated CBN
PCD	PCD/Diamond
CVD	CVD Diamond



## APPLICATIONS

- ▲ PREMIUM choice for the universal turning of steels
- ▲ Highly wear-resistant grade
- ▲ Designed for maximum cutting parameters / high productivity, long tool life, dry machining

## YOUR ADVANTAGES

- ▲ Available from standard range
- ▲ Easy wear detection with special top layer on coating

## YOUR BENEFITS

- ▲ High productivity
- ▲ Increased tool life

### P25CX

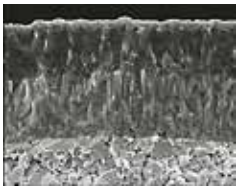

### HC-P25 / HC-K30 / HC-20

**Specification:**

Composition: Co 7.6%; mixed carbides 7.0%; others 0.4%; WC balance | Grain size: 1-2 $\mu$ m | Hardness: HV<sub>30</sub> 1470 | Coating specification: CVD TiCN-Al<sub>2</sub>O<sub>3</sub> top layer

**Recommended application:**

The first and premium choice for the universal machining of steel

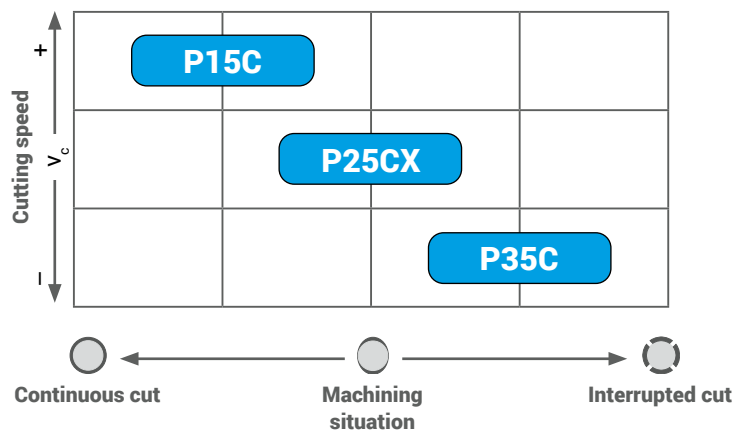

## AVAILABLE RANGE

Inserts	Designation	Grade	Chipbreaker	Material number
	CNMG120408MRU	P25CX	...-MRU	12245949
	CNMG120412MRU	P25CX		12245954
	DNMG150608MRU	P25CX		12245956
	TNMG160408MRU	P25CX		12245955
	SNMG120408MRU	P25CX		12245950
	WNMG080408MRU	P25CX		12245952
	WNMG080412MRU	P25CX		12245953



## APPLICATIONS

*The M20CX is suitable for:*

- ▲ High cutting parameters in wet cutting
- ▲ Better resistance to plastic deformation and higher heat resistance in operation
- ▲ Continuous to slightly interrupted cut

## YOUR ADVANTAGES

- ▲ Two grades for everything in stainless steel
- ▲ Easy selection of inserts
- ▲ Easy wear detection with yellow top layer on coating
- ▲ Tool life increased

## YOUR BENEFITS

- ▲ Productivity
- ▲ Reduced warehousing costs

### M20CX

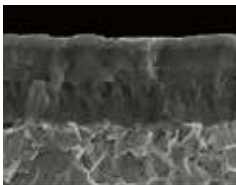

### HC-M20 / HC-P30

**Specification:**

Composition: Co 7.6%; mixed carbides 7.0%; others 0.4%; WC balance | Grain size: 1-2µm | Hardness: HV<sub>30</sub> 1470 | Coating specification: CVD TiCN-Al<sub>2</sub>O<sub>3</sub>-Top layer.

**Recommended application:**

It brings advantages to dry machining, at even higher cutting speeds, and makes long tool life possible.



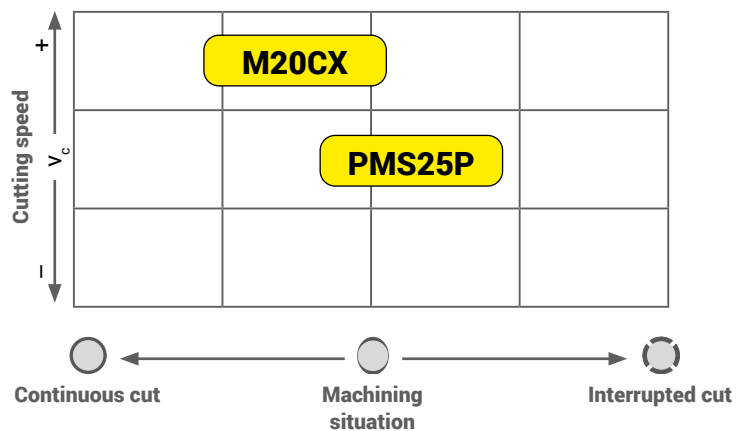

## AVAILABLE RANGE

Inserts	Designation	Grade	Chipbreaker	Material number
	CNMG120404MM	M20CX	...MM	12233866
	CNMG120408MM	M20CX		12233867
	DNMG150604MM	M20CX		12233869
	DNMG150608MM	M20CX		12233868
	WNMG080404MM	M20CX		12233872
	WNMG080408MM	M20CX		12233870



## APPLICATIONS

*The K10CX is suitable for:*

- ▲ Stable machining conditions
- ▲ High cutting speeds
- ▲ Continuous to slightly interrupted cut
- ▲ Dry machining of spheroidal cast iron (GGG) / compacted graphite iron (CGI) (grey cast iron (GG) at high Vc with smooth cut)

## YOUR ADVANTAGES

- ▲ Existing in standard range
- ▲ Highly wear-resistant grade
- ▲ Very good process security
- ▲ Two grades for everything in cast iron
- ▲ Easy selection of inserts

## YOUR BENEFITS

- ▲ Reduced warehousing costs
- ▲ The right insert available for every application
- ▲ Maximum cutting parameters / high productivity, long tool life, dry machining

### K10CX

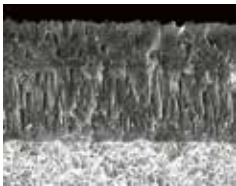

### HC-K10 / HC-P05

**Specification:**

Composition: Co 5.0%; mixed carbides 2.0%; WC balance | Grain size: submicron | Hardness: HV<sub>30</sub> 1810  
| Coating specification: CVD TiCN-Al<sub>2</sub>O<sub>3</sub>

**Recommended application:**

The wear-resistant grade for the machining of cast iron at high cutting speed with continuous cut

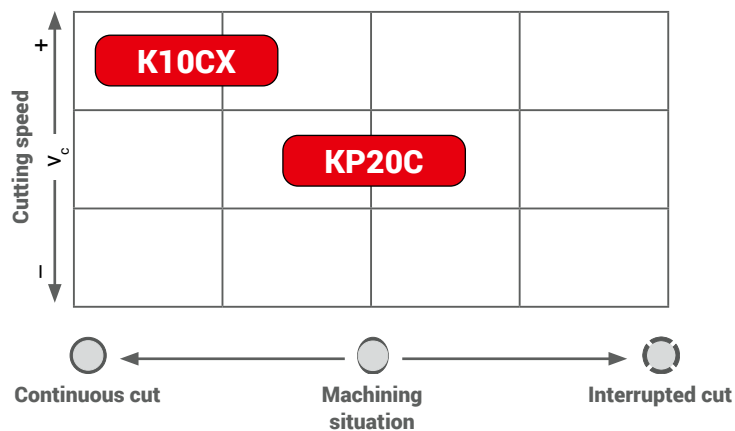

## AVAILABLE RANGE

Inserts	Designation	Grade	Chipbreaker	Material number
	CNMG120408RPK	K10CX	...-RPK	12149710
	CNMG120412RPK	K10CX		12200956
	CNMG160612RPK	K10CX		12200958
	SNMG120412RPK	K10CX		12200959
	WNMG080408RPK	K10CX		12200960
	WNMG080412RPK	K10CX		12200954
	CNMA120408	K10CX	12234327	
	WNMA080412	K10CX	-	12234328

# SINGLE SIDED INSERTS



# CHIPBREAKER -WUP

- ▲ Positive Wiper geometry
- ▲ High surface quality

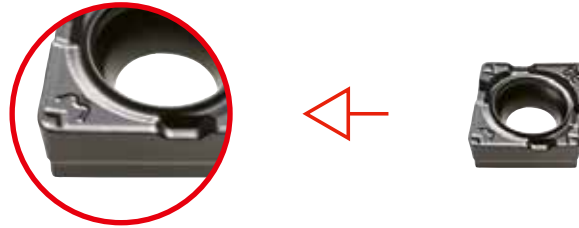

## CUTTING DATA

General cutting parameters depending on the application

Work piece material	Type of treatment / alloy	Hardness HB	P15C	P25C	P35C
			$v_c$ [m/min]	$v_c$ [m/min]	$v_c$ [m/min]
P Steel	Non-alloyed steel 0-0.45% C	150-250	220-400	170-240	170-190
	Low-alloyed steel	250-300	200-320	100-190	90-150
	High-alloyed steel	200	180-320	130-210	120-200
	Corrosion-resistant steel	200	200-320	130-210	140-180
M Stainless steel	Ferritic	200	220-320	140-210	140-200
	Austenitic	180	-	100-210	110-190
	Duplex	230-260	-	-	80-150
	Martensitic	330	-	70-100	55-75
K Cast iron	Grey cast iron	180	140-370	130-210	-
	Spheroidal	160	190-430	120-240	-
	Malleable/tempered iron	130	180-520	150-250	-

Application	Depth of cut / feed rate	
	$a_p$ [mm]	$f$ [mm]
Chip groove WUP	1 to 3.5	0.15 to 0.30

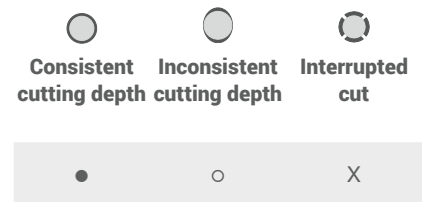

# AVAILABLE RANGE



WIPER

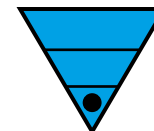

## Steel extreme finishing – Wiper

Insert	Designation	Grade	Chipbreaker	Material number	Available
	CCMX09T304WUP	P25C		12078108	●
	CCMX09T308WUP	P25C		12078100	●
	DCMX070204WUP	P25C	...-WUP	12078103	●
	DCMX11T304WUP	P25C		12078101	●
	DCMX11T308WUP	P25C		12086875	●

# OPERATING PRINCIPLE

## Improved surface finish

With the same feed rate an insert with Wiper cutting edge reaches a roughness value  $R_a$  which is many times higher than the one of a conventional insert.

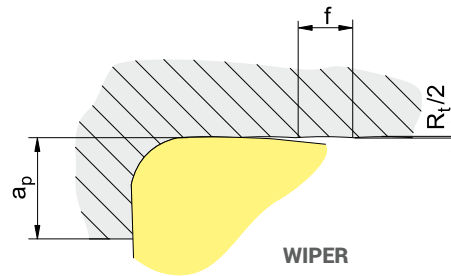
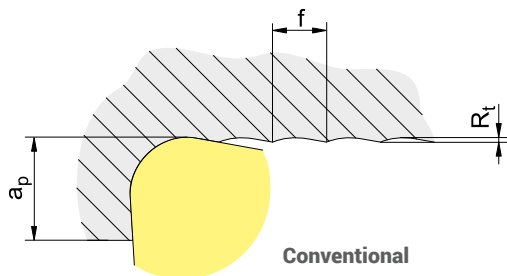

# CHIPBREAKER -FC

- ▲ Increased tool life
- ▲ Small feed rate when bar turning

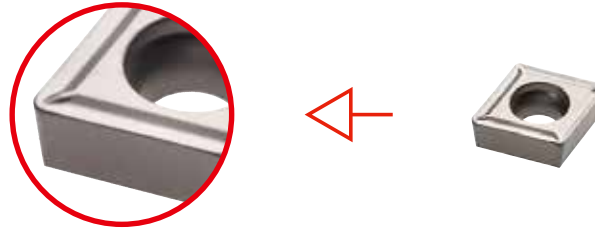

## CUTTING DATA

General cutting parameters depending on the application

Work piece material	Type of treatment / alloy	Hardness HB	Cermet PMH10T	
			$v_c$ [m/min]	
P	Non-alloyed steel 0-0.45% C	150-250	230-270	
	Steel	Low-alloyed steel	250-300	180-230
		High-alloyed steel	200	160-200
		Corrosion-resistant steel	200	230-270
M	Stainless steel	Ferritic	200	170-240
		Austenitic	180	200-240
		Duplex	230-260	-
		Martensitic	330	130-160
K	Cast iron	Grey cast iron	180	-
		Spheroidal	160	220-300
		Malleable/tempered iron	130	250-350

Application Chip groove	Depth of cut / feed rate	
	$a_p$ [mm]	$f$ [mm]
FC	0.1 to 1.65	0.05 to 0.20

Consistent cutting depth	Inconsistent cutting depth	Interrupted cut
●	X	X



# AVAILABLE RANGE

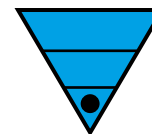

## Turning steel pos finishing "CERMET"

Insert	Designation	Grade	Chipbreaker	Material number	Available	
	CCMT060204FC	PMH10T	...-FC	11619142	●	
	CCMT09T304FC	PMH10T		11619132	●	
	DCMT070204FC	PMH10T		11619127	●	
	DCMT11T304FC	PMH10T		11619131	●	
	TCGT110202FC	PMH10T		11622263	●	
	TCMT110204FC	PMH10T		11619126	●	
	WCGT020102FC	PMH10T		11619140	●	

# CHIPBREAKER -MU

▲ To optimize the control of the chip



## CUTTING DATA

General cutting parameters depending on the application

Work piece material	Type of treatment / alloy	Hardness HB	Coated carbide			Application	Depth of cut / feed rate		
			P15C	P25C	P35C		Chip groove	$a_p$ [mm]	f [mm]
			$v_c$ [m/min]	$v_c$ [m/min]	$v_c$ [m/min]				
P	Non-alloyed steel 0-0.45% C	150-250	220-400	170-240	170-190	MU	0.50 to 2.25	0.07 to 0.14	
	Steel								
	Low-alloyed steel	250-300	200-320	100-190	90-150				
	High-alloyed steel	200	180-320	130-210	120-200				
	Corrosion-resistant steel	200	200-320	130-210	140-180				
M	Stainless steel								
	Ferritic	200	220-320	140-210	140-200				
	Austenitic	180	-	100-210	110-190				
	Duplex	230-260	-	-	80-150				
	Martensitic	330	-	70-100	55-75				
K	Cast iron								
	Grey cast iron	180	140-370	130-210	-				
	Spheroidal	160	190-430	120-240	-				
	Malleable/tempered iron	130	180-520	150-250	-				

Consistent cutting depth	Inconsistent cutting depth	Interrupted cut
●	○	⊗
●	○	X

# AVAILABLE RANGE

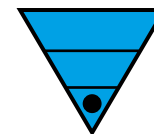

## Turning steel pos finishing "P15"

Insert	Designation	Grade	Chipbreaker	Material number	Available
	CCMT060204MU	P15C	...-MU	12030470	●
	CCMT09T304MU	P15C		12030511	●
	CCMT09T308MU	P15C		12030567	●
	CCMT120404MU	P15C		12030568	●
	DCMT070204MU	P15C		12030692	●
	DCMT11T304MU	P15C		12167861	●

# CHIPBREAKER -MU

▲ To optimize the control of the chip

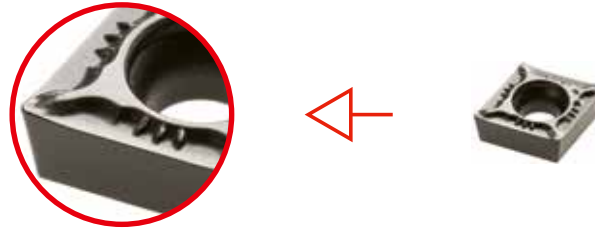

## CUTTING DATA

General cutting parameters depending on the application

Work piece material	Type of treatment / alloy	Hardness HB	Coated carbide			Application	Depth of cut / feed rate		
			P15C	P25C	P35C		Chip groove	$a_p$ [mm]	f [mm]
			$v_c$ [m/min]	$v_c$ [m/min]	$v_c$ [m/min]				
P	Non-alloyed steel 0-0.45% C	150-250	220-400	170-240	170-190	MU	0.50 to 2.25	0.07 to 0.14	
	Steel								
	Low-alloyed steel	250-300	200-320	100-190	90-150				
	High-alloyed steel	200	180-320	130-210	120-200				
	Corrosion-resistant steel	200	200-320	130-210	140-180				
M	Stainless steel								
	Ferritic	200	220-320	140-210	140-200				
	Austenitic	180	-	100-210	110-190				
	Duplex	230-260	-	-	80-150				
	Martensitic	330	-	70-100	55-75				
K	Cast iron								
	Grey cast iron	180	140-370	130-210	-				
	Spheroidal	160	190-430	120-240	-				
	Malleable/tempered iron	130	180-520	150-250	-				



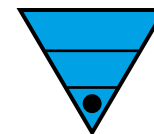

Consistent cutting depth	Inconsistent cutting depth	Interrupted cut
●	○	⊗
●	○	X

# AVAILABLE RANGE



## Turning steel pos finishing "P25"

Insert	Designation	Grade	Chipbreaker	Material number	Available
	CCMT060202MU	P25C	...-MU	11684867	●
	CCMT060204MU	P25C		11684913	●
	CCMT09T302MU	P25C		11684916	●
	CCMT09T304MU	P25C		11684923	●
	CCMT09T308MU	P25C		11684931	●
DCMT070202MU	P25C	11684952		●	
	DCMT070204MU	P25C		11684953	●
	DCMT11T302MU	P25C		11812677	●
	DCMT11T304MU	P25C		11686178	●
	DCMT11T308MU	P25C		11686185	●
	VCMT110302MU	P25C		11812680	●
	VCMT110304MU	P25C	11855132	●	
	VCMT160404MU	P25C	11812683	●	
	VCMT160408MU	P25C	12077363	●	

# CHIPBREAKER -MU

▲ To optimize the control of the chip



## CUTTING DATA

General cutting parameters depending on the application

Work piece material	Type of treatment / alloy	Hardness HB	Coated carbide			Application	Depth of cut / feed rate		
			P15C	P25C	P35C		Chip groove	$a_p$ [mm]	f [mm]
			$v_c$ [m/min]	$v_c$ [m/min]	$v_c$ [m/min]				
P	Non-alloyed steel 0-0.45% C	150-250	220-400	170-240	170-190	MU	0.50 to 2.25	0.07 to 0.14	
	Steel								
	Low-alloyed steel	250-300	200-320	100-190	90-150				
	High-alloyed steel	200	180-320	130-210	120-200				
	Corrosion-resistant steel	200	200-320	130-210	140-180				
M	Stainless steel								
	Ferritic	200	220-320	140-210	140-200				
	Austenitic	180	-	100-210	110-190				
	Duplex	230-260	-	-	80-150				
	Martensitic	330	-	70-100	55-75				
K	Cast iron								
	Grey cast iron	180	140-370	130-210	-				
	Spheroidal	160	190-430	120-240	-				
	Malleable/tempered iron	130	180-520	150-250	-				

Consistent cutting depth	Inconsistent cutting depth	Interrupted cut
●	○	⊗
●	○	X

# AVAILABLE RANGE

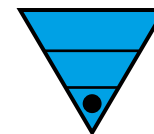

## Turning steel pos finishing "P35"

Insert	Designation	Grade	Chipbreaker	Material number	Available
	CCMT09T308MU	P35C	...-MU	12051804	●





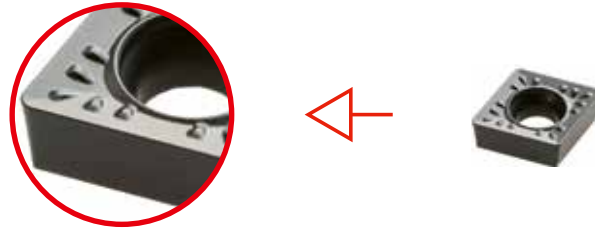

# CHIPBREAKER -MRU

- ▲ Increased life time
- ▲ Reduce temperature and stress
- ▲ Universal application



## CUTTING DATA

General cutting parameters depending on the application

Work piece material	Type of treatment / alloy	Hardness HB	Coated carbide			Application	Depth of cut / feed rate		
			P15C	P25C	P35C		Chip groove	$a_p$ [mm]	f [mm]
			$v_c$ [m/min]	$v_c$ [m/min]	$v_c$ [m/min]				
P	Non-alloyed steel 0-0.45% C	150-250	220-400	170-240	170-190	MRU	0.50 to 3.00	0.12 to 0.21	
	Low-alloyed steel	250-300	200-320	100-190	90-150				
	High-alloyed steel	200	180-320	130-210	120-200				
	Corrosion-resistant steel	200	200-320	130-210	140-180				
M	Ferritic	200	220-320	140-210	140-200	 Consistent cutting depth	 Inconsistent cutting depth	 Interrupted cut	
	Austenitic	180	-	100-210	110-190				
	Duplex	230-260	-	-	80-150				
	Martensitic	330	-	70-100	55-75				
K	Grey cast iron	180	140-370	130-210	-	  			
	Spheroidal	160	190-430	120-240	-				
	Malleable/tempered iron	130	180-520	150-250	-				



# AVAILABLE RANGE

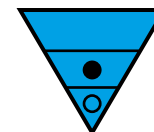

## Turning steel pos medium "P15"

Insert	Designation	Grade	Chipbreaker	Material number	Available	
	CCMT060204MRU	P15C	...-MRU	11865625	●	
	CCMT060208MRU	P15C		12064721	●	
	CCMT09T304MRU	P15C		11888980	●	
	CCMT09T308MRU	P15C		11888982	●	
	DCMT11T304MRU	P15C		11865628	●	
	DCMT11T308MRU	P15C		11865630	●	
	SCMT120404MRU	P15C		11865632	●	
	TCMT110204MRU	P15C		12030597	●	
	VBMT160404FP	P15C		...-FP	12057972	●





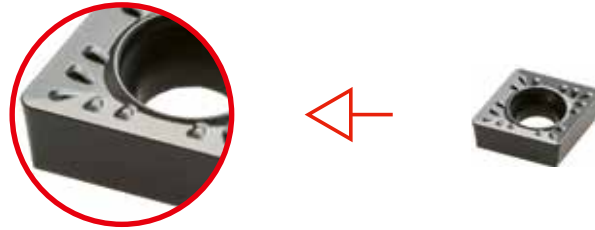

# CHIPBREAKER -MRU

- ▲ Increased life time
- ▲ Reduce temperature and stress
- ▲ Universal application



## CUTTING DATA





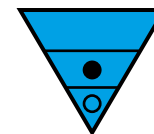

General cutting parameters depending on the application

Work piece material	Type of treatment / alloy	Hardness HB	Coated carbide			Application	Depth of cut / feed rate		
			P15C	P25C	P35C		Chip groove	$a_p$ [mm]	f [mm]
			$v_c$ [m/min]	$v_c$ [m/min]	$v_c$ [m/min]				
P	Non-alloyed steel 0-0.45% C	150-250	220-400	170-240	170-190	MRU	0.50 to 3.00	0.12 to 0.21	
	Low-alloyed steel	250-300	200-320	100-190	90-150				
	High-alloyed steel	200	180-320	130-210	120-200				
	Corrosion-resistant steel	200	200-320	130-210	140-180				
M	Ferritic	200	220-320	140-210	140-200	 Consistent cutting depth	 Inconsistent cutting depth	 Interrupted cut	
	Austenitic	180	-	100-210	110-190				
	Duplex	230-260	-	-	80-150				
	Martensitic	330	-	70-100	55-75				
K	Grey cast iron	180	140-370	130-210	-	  			
	Spheroidal	160	190-430	120-240	-				
	Malleable/tempered iron	130	180-520	150-250	-				

# AVAILABLE RANGE



## Turning steel pos medium "P25"

Insert	Designation	Grade	Chipbreaker	Material number	Available
	CCMT060204MRU	P25C		11748108	●
	CCMT060208MRU	P25C		11748110	●
	CCMT09T304MRU	P25C		11748112	●
	CCMT09T308MRU	P25C		11748114	●
	CCMT120404MRU	P25C		11748116	●
	CCMT120408MRU	P25C		11748118	●
	CCMT120412MRU	P25C		11748120	●
	DCMT070204MRU	P25C		11748124	●
	DCMT070208MRU	P25C		11748127	●
	DCMT11T304MRU	P25C		11748129	●
	DCMT11T308MRU	P25C		11748131	●
	SCMT09T304MRU	P25C	...-MRU	11748539	●
	SCMT09T308MRU	P25C		11748556	●
	SCMT120404MRU	P25C		11748562	●
	SCMT120408MRU	P25C		11748566	●
	SCMT120412MRU	P25C		11748579	●
	TCMT090204MRU	P25C		11748602	●
	TCMT110204MRU	P25C		11748607	●
	TCMT110208MRU	P25C		11748609	●
	TCMT16T304MRU	P25C		11748620	●
	TCMT16T308MRU	P25C		11748622	●
	TCMT16T312MRU	P25C		11748625	●
	VCMT110304MRU	P25C		11749275	●
	VCMT110308MRU	P25C		11749283	●
	VCMT160404MRU	P25C		11687010	●
	VCMT160408MRU	P25C		11687012	●
	VBMT160404FP	P25C	...-FP	11687006	●
	VBMT160408FP	P25C		11687008	●
	WCMT040204MRU	P25C	...-MRU	11749299	●
	WCMT040208MRU	P25C		11749304	●
	WCMT06T304MRU	P25C		11749313	●
	WCMT06T308MRU	P25C		11749317	●
	WCMT080404MRU	P25C		11749333	●
	WCMT080408MRU	P25C		11749336	●
	WCMT080412MRU	P25C		11749340	●





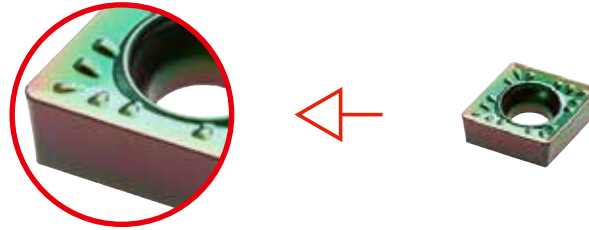

# CHIPBREAKER -MRU

- ▲ Increased life time
- ▲ Reduce temperature and stress
- ▲ Universal application



## CUTTING DATA

General cutting parameters depending on the application

Work piece material	Type of treatment / alloy	Hardness HB	Coated carbide			Application	Depth of cut / feed rate		
			P15C	P25C	P35C		Chip groove	$a_p$ [mm]	f [mm]
			$v_c$ [m/min]	$v_c$ [m/min]	$v_c$ [m/min]				
P	Non-alloyed steel 0-0.45% C	150-250	220-400	170-240	170-190	MRU	0.50 to 3.00	0.12 to 0.21	
	Low-alloyed steel	250-300	200-320	100-190	90-150				
	High-alloyed steel	200	180-320	130-210	120-200				
	Corrosion-resistant steel	200	200-320	130-210	140-180				
M	Ferritic	200	220-320	140-210	140-200	 <b>Consistent cutting depth</b>	 <b>Inconsistent cutting depth</b>	 <b>Interrupted cut</b>	
	Austenitic	180	-	100-210	110-190				
	Duplex	230-260	-	-	80-150				
	Martensitic	330	-	70-100	55-75				
K	Grey cast iron	180	140-370	130-210	-	  			
	Spheroidal	160	190-430	120-240	-				
	Malleable/tempered iron	130	180-520	150-250	-				

# AVAILABLE RANGE

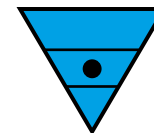

## Turning steel pos medium "P35"

Insert	Designation	Grade	Chipbreaker	Material number	Available
	CCMT060204MRU	P35C	...-MRU	11854303	●
	CCMT060208MRU	P35C		11854307	●
	CCMT09T304MRU	P35C		11854315	●
	CCMT09T308MRU	P35C		11854322	●
	DCMT070204MRU	P35C		11854804	●
	DCMT070208MRU	P35C		11854807	●
	DCMT11T304MRU	P35C		11854850	●
	DCMT11T308MRU	P35C		11854863	●
	RCMT0803MOMRU	P35C		11882921	●
	RCMT1003MOMRU	P35C		11882920	●
	RCMT1204MOMRU	P35C		11855077	●
	SCMT09T308MRU	P35C		11855088	●
	SCMT120408MRU	P35C		11855090	●
	SCMT120412MRU	P35C		11855099	●
	TCMT110204MRU	P35C		11873284	●
	TCMT110208MRU	P35C		11873281	●
	TCMT16T304MRU	P35C	11855125	●	
	TCMT16T308MRU	P35C	11855126	●	
	VCMT110304MRU	P35C	11873280	●	
	VCMT110308MRU	P35C	11873279	●	
	VCMT160404MRU	P35C	11855136	●	
	VCMT160408MRU	P35C	11855137	●	

# CHIPBREAKER -WUP

- ▲ Positive WIPER geometry
- ▲ High surface quality

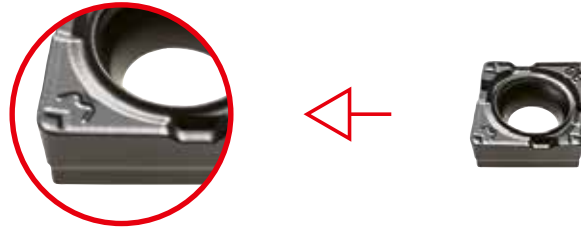

## CUTTING DATA

General cutting parameters depending on the application

Work piece material	Type of treatment / alloy	Hardness HB	P25C	MP35P
			$v_c$ [m/min]	$v_c$ [m/min]
P	Non-alloyed steel 0-0.45% C	150-250	170-240	170-190
	Low-alloyed steel	250-300	100-190	90-150
	High-alloyed steel	200	130-210	120-200
	Corrosion-resistant steel	200	130-210	140-180
M	Ferritic	200	140-210	140-200
	Austenitic	180	100-210	110-190
	Duplex	230-260	-	80-150
	Martensitic	330	70-100	55-75
K	Grey cast iron	180	130-210	-
	Spheroidal	160	120-240	-
	Malleable/tempered iron	130	150-250	-

Application	Depth of cut / feed rate	
	$a_p$ [mm]	$f$ [mm]
Chip groove		
WUP	1 to 3.50	0.15 to 0.30

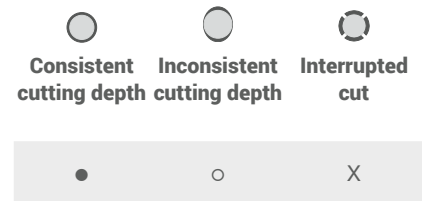



# AVAILABLE RANGE

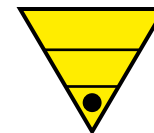

WIPER



## Turning steel pos "P35" – WIPER

Insert	Designation	Grade	Chipbreaker	Material number	Available
	CCMX09T304WUP	MP35P	...-WUP	12078102	●
	CCMX09T308WUP	MP35P		12078097	●
	DCMX11T304WUP	MP35P		12078099	●
	DCMX11T308WUP	MP35P		12078094	●

# OPERATING PRINCIPLE

## Improved surface finish

With the same feed rate an insert with WIPER cutting edge reaches a roughness value  $R_a$  which is many times higher than the one of a conventional insert.

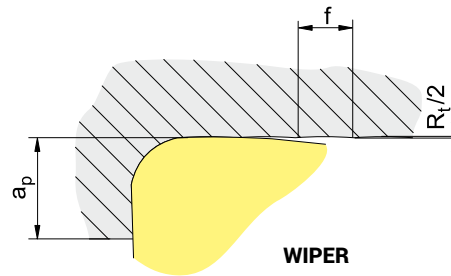
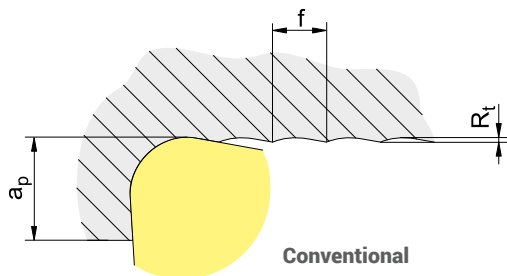

# CUTTING DATA -EF



General cutting parameters depending on the application

Work piece material	Type of treatment / alloy	Hardness HB	Coated carbide	
			MK20P	$v_c$ [m/min]
M	Ferritic	200		150-200
	Austenitic	180		120-200
	Duplex	230-260		90-160
	Martensitic	330		60-80
K	Grey cast iron	180		120-160
	Spheroidal	160		120-160
	Malleable/tempered iron	130		140-220
N	Non Ferrous	100		100-400
		130		100-400
		90		100-600
		100		100-400
S	Fe base	200		20-50
	Nickel or cobalt base	280		20-50
	Nickel or cobalt base	250		15-40
	Nickel or cobalt base			20-35
	Titanium	Rm 440*		80-140

Application	Depth of cut / feed rate	
Chip groove	$a_p$ [mm]	$f$ [mm]
EF	0.05 to 1.35	0.02 to 0.10



●	X	X
---	---	---



# AVAILABLE RANGE

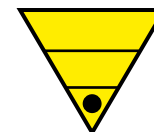

## Turning stainless steel pos "Extreme finishing"

Insert	Designation	Grade	Chipbreaker	Material number	Available
	CCGT060200EF	MK20P	...EF	11204029	●
	CCGT060201EF	MK20P		11203024	●
	CCGT09T300EF	MK20P		11204030	●
	CCGT09T301EF	MK20P		11203027	●
	DCGT070200EF	MK20P		11204031	●
	DCGT070201EF	MK20P		11203028	●
	DCGT11T300EF	MK20P		11204035	●
	DCGT11T301EF	MK20P		11203030	●
	VCGT110300EF	MK20P		11204036	●
	VCGT110301EF	MK20P		11203033	●
	VCGT160400EF	MK20P		11204037	●
	VCGT160401EF	MK20P		11203034	●

# CHIPBREAKER -FU

- ▲ Increased life expectancy
- ▲ Small feedrate in bar turning



## CUTTING DATA

General cutting parameters depending on the application

Work piece material	Type of treatment / alloy	Coated carbide		
		Hardness HB	MS15P $v_c$ [m/min]	
K	Cast iron	Grey cast iron	180	-
		Spheroidal	160	-
		Malleable/tempered iron	130	-
N	Alu Cuivre		100	100-2000
			130	100-800
			90	100-600
			100	100-300
S	Exotic materials	Fe base	200	30-45
		Nickel or Kobalt base	280	20-35
		Nickel or Kobalt base	250	20-35
		Nickel or Kobalt base		18-30
		Titanium	Rm 440*	60-120

Application	Depth of cut / feed rate	
	$a_p$ [mm]	f [mm]
Chip groove FU	0.05 to 1.35	0.02 to 0.10



  
**Consistent cutting depth**    **Inconsistent cutting depth**    **Interrupted cut**



# AVAILABLE RANGE

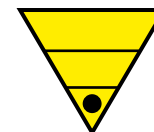

## Turning stainless steel pos finishing "M15"

Insert	Designation	Grade	Chipbreaker	Material number	Available
	CCGT060201FU	MS15P	...	11973505	●
	CCGT060202FU	MS15P		11969606	●
	CCGT060202FU	MS15P		11969605	●
	CCGT09T302FU	MS15P		11969607	●
	CCGT09T304FU	MS15P		11969604	●
	CCGT09T308FU	MS15P		11969600	●
	CCGT120404FU	MS15P		11969598	●
	CCGT120408FU	MS15P		11969596	●
	DCGT070201FU	MS15P	...	11969599	●
	DCGT070202FU	MS15P		11969597	●
	DCGT070204FU	MS15P		11969595	●
	DCGT11T302FU	MS15P		11969591	●
	DCGT11T304FU	MS15P		11969585	●
	DCGT11T308FU	MS15P		11969579	●
	SCGT09T304FU	MS15P	...	11969578	●
	SCGT09T308FU	MS15P		12042223	●
	SCGT120408FU	MS15P		12049241	●
	TCGT110204FU	MS15P	...	12044368	●
	VCGT110302FU	MS15P	...	11969577	●
	VCGT110304FU	MS15P		11969575	●
	VCGT130302FU	MS15P		11969568	●
	VCGT130304FU	MS15P		11969566	●
	VCGT160404FU	MS15P		11969535	●
	VCGT160408FU	MS15P		11969529	●
	VCGT160412FU	MS15P		11969360	●

# CHIPBREAKER -FC

- ▲ Increased life time
- ▲ Small feedrate in bar turning

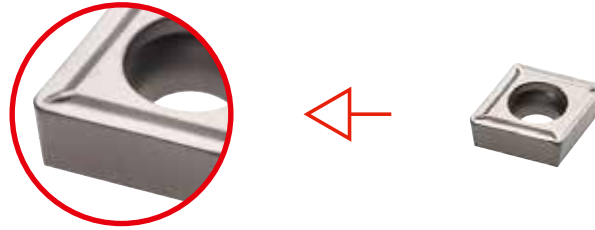

## CUTTING DATA

General cutting parameters depending on the application

Work piece material	Type of treatment / alloy	Hardness HB	Cermet PMH10T	
			$v_c$ [m/min]	
P	Non-alloyed steel 0-0.45% C	150-250	230-270	
	Steel	Low-alloyed steel	250-300	180-230
		High-alloyed steel	200	160-200
		Corrosion-resistant steel	200	230-270
M	Stainless steel	Ferritic	200	170-240
		Austenitic	180	200-240
		Duplex	230-260	-
		Martensitic	330	130-160
K	Cast iron	Grey cast iron	180	-
		Spheroidal	160	220-300
		Malleable/tempered iron	130	250-350



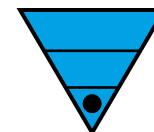

Application Chip groove	Depth of cut / feed rate	
	$a_p$ [mm]	$f$ [mm]
FC	0.10 to 1.65	0.05 to 0.20

Consistent cutting depth	Inconsistent cutting depth	Interrupted cut
●	X	X

# AVAILABLE RANGE



## Turning stainless steel pos finishing "CERMET"

Insert	Designation	Grade	Chipbreaker	Material number	Available	
	CCMT060204FC	PMH10T	...-FC	11619142	●	
	CCMT09T304FC	PMH10T		11619132	●	
	DCMT070204FC	PMH10T		11619127	●	
	DCMT11T304FC	PMH10T		11619131	●	
	TCGT110202FC	PMH10T		11622263	●	
	TCMT110204FC	PMH10T		11619126	●	
	WCGT020102FC	PMH10T		11619140	●	

# CHIPBREAKER -MU

▲ To optimize the control of the chip

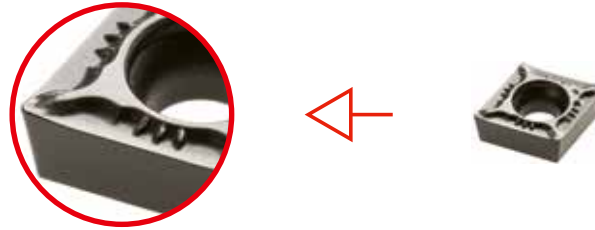

## CUTTING DATA

General cutting parameters depending on the application

Work piece material	Type of treatment / alloy	Hardness HB	Coated carbide	
			PMS25P	MP35P
			$v_c$ [m/min]	$v_c$ [m/min]
P	Non-alloyed steel 0-0.45% C	150-250	130-250	170-190
	Low-alloyed steel	250-300	60-180	90-150
	High-alloyed steel	200	80-200	120-200
	Corrosion-resistant steel	200	100-200	140-180
M	Ferritic	200	120-250	140-200
	Austenitic	180	100-220	110-190
	Duplex	230-260	60-160	80-150
	Martensitic	330	40-100	55-75

Application	Depth of cut / feed rate	
Chip groove	$a_p$ [mm]	$f$ [mm]
MU	0.50 to 2.25	0.07 to 0.14

Consistent cutting depth	Inconsistent cutting depth	Interrupted cut
●	○	X

# AVAILABLE RANGE



## Turning steel pos finishing "M25"

Insert	Designation	Grade	Chipbreaker	Material number	Available
	CCMT060202MU	PMS25P	...-MU	11782035	●
	CCMT060204MU	PMS25P		11782037	●
	CCMT09T302MU	PMS25P		11782051	●
	CCMT09T304MU	PMS25P		11782052	●
	CCMT09T308MU	PMS25P		11782054	●
	DCMT070202MU	PMS25P		11782055	●
	DCMT070204MU	PMS25P		11782056	●
	DCMT11T302MU	PMS25P		11812678	●
	DCMT11T304MU	PMS25P		11782058	●
	DCMT11T308MU	PMS25P		11782059	●
	TCMT110202MU	PMS25P		11906411	●
	VCMT110302MU	PMS25P		11812682	●
	VCMT110304MU	PMS25P		11855134	●
	VCMT160404MU	PMS25P		11812684	●

# CHIPBREAKER -MRU

- ▲ Increased life time
- ▲ Reduce temperature and stress
- ▲ Universal application

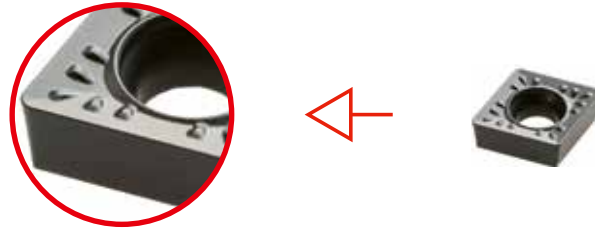

## CUTTING DATA

General cutting parameters depending on the application

Work piece material	Type of treatment / alloy	Hardness HB	Coated carbide	
			PMS25P	MP35P
			$v_c$ [m/min]	$v_c$ [m/min]
P	Non-alloyed steel 0 – 0.45% C	150-250	130-250	170-190
	Low-alloyed steel	250-300	60-180	90-150
	High-alloyed steel	200	80-200	120-200
	Corrosion-resistant steel	200	100-200	140-180
M	Ferritic	200	120-250	140-200
	Austenitic	180	100-220	110-190
	Duplex	230 – 260	60-160	80-150
	Martensitic	330	40-100	55-75

Application	Depth of cut / feed rate	
Chip groove	$a_p$ [mm]	$f$ [mm]
MRU	0.50 to 3.00	0.12 to 0.21

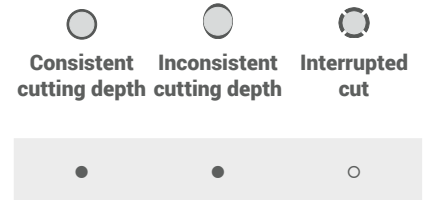



# AVAILABLE RANGE

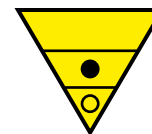

## Turning stainless steel pos "M25"

Insert	Designation	Grade	Chipbreaker	Material number	Available
	CCMT060204MRU	PMS25P		11748109	●
	CCMT060208MRU	PMS25P		11748111	●
	CCMT09T304MRU	PMS25P		11748113	●
	CCMT09T308MRU	PMS25P		11748115	●
	CCMT120404MRU	PMS25P		11748117	●
	CCMT120408MRU	PMS25P		11748119	●
	CCMT120412MRU	PMS25P		11748121	●
	DCMT070204MRU	PMS25P		11748126	●
	DCMT070208MRU	PMS25P		11748128	●
	DCMT11T304MRU	PMS25P		11748130	●
	DCMT11T308MRU	PMS25P		11748132	●
	SCMT09T304MRU	PMS25P		11748548	●
	SCMT09T308MRU	PMS25P		11748559	●
	SCMT120404MRU	PMS25P		11748564	●
	SCMT120408MRU	PMS25P		11748568	●
	SCMT120412MRU	PMS25P	...-MRU	11748592	●
	TCMT090204MRU	PMS25P		11748606	●
	TCMT110204MRU	PMS25P		11748608	●
	TCMT110208MRU	PMS25P		11748618	●
	TCMT16T304MRU	PMS25P		11748621	●
	TCMT16T308MRU	PMS25P		11748624	●
	TCMT16T312MRU	PMS25P		11748626	●
	VCMT110304MRU	PMS25P		11749277	●
	VCMT110308MRU	PMS25P		11749294	●
	VCMT160404MRU	PMS25P		11749295	●
	VCMT160408MRU	PMS25P		11749296	●
	WCMT040204MRU	PMS25P		11749303	●
	WCMT040208MRU	PMS25P		11749307	●
	WCMT06T304MRU	PMS25P		11749314	●
	WCMT06T308MRU	PMS25P		11749331	●
	WCMT080404MRU	PMS25P		11749335	●
	WCMT080408MRU	PMS25P		11749337	●
	WCMT080412MRU	PMS25P		11747968	●

# CHIPBREAKER -MRU

- ▲ Increased life time
- ▲ Reduce temperature and stress
- ▲ Universal application

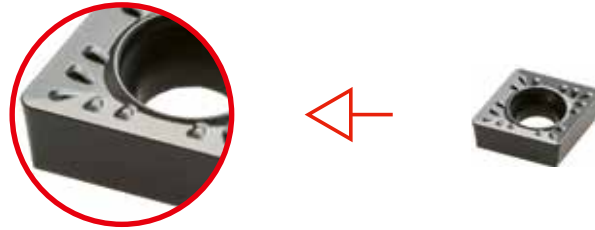

## CUTTING DATA

General cutting parameters depending on the application

Work piece material	Type of treatment / alloy	Hardness HB	Coated carbide	
			PMS25P	MP35P
			$v_c$ [m/min]	$v_c$ [m/min]
P	Non-alloyed steel 0-0.45% C	150-250	130-250	170-190
	Low-alloyed steel	250-300	60-180	90-150
	High-alloyed steel	200	80-200	120-200
	Corrosion-resistant steel	200	100-200	140-180
M	Ferritic	200	120-250	140-200
	Austenitic	180	100-220	110-190
	Duplex	230-260	60-160	80-150
	Martensitic	330	40-100	55-75

Application	Depth of cut / feed rate	
Chip groove	$a_p$ [mm]	$f$ [mm]
MRU	0.50 to 3.00	0.12 to 0.21

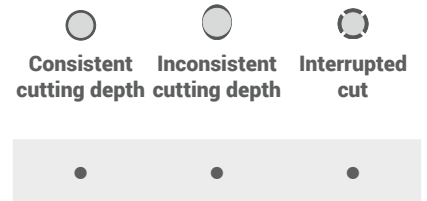

# AVAILABLE RANGE

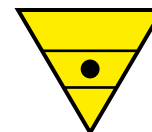

## Turning stainless steel pos "M35"

Insert	Designation	Grade	Chipbreaker	Material number	Available
	CCMT09T304MRU	MP35P	...-MRU	11854319	●
	CCMT09T308MRU	MP35P		11854326	●
	DCMT11T304MRU	MP35P		11854853	●
	DCMT11T308MRU	MP35P		11854898	●
	TCMT110204MRU	MP35P		11855120	●
	TCMT110208MRU	MP35P		11855122	●
	VCMT110304MRU	MP35P		11855131	●
	VCMT110308MRU	MP35P		11855135	●

# CHIPBREAKER -MRU

- ▲ Increased life time
- ▲ Reduce temperature and stress
- ▲ Universal application



## CUTTING DATA

General cutting parameters depending on the application



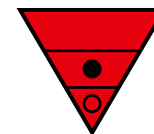

Work piece material	Type of treatment / alloy	Hardness HB	Coated carbide	
			Hardness HB	$v_c$ [m/min]
P	Non-alloyed steel 0-0.45% C	150-250	200-340	
	Low-alloyed steel	250-300	150-290	
	High-alloyed steel	200	150-290	
	Corrosion-resistant steel	200	160-290	
K	Grey cast iron	180	150-400	
	Spheroidal	160	200-450	
	Malleable/tempered iron	130	200-550	

Application	Depth of cut / feed rate		
	$a_p$ [mm]	$a_p$ [mm]	
Chip groove			
MRU	1.00 to 3.00	0.22 to 0.41	
	Consistent cutting depth	Inconsistent cutting depth	Interrupted cut
	●	●	X

# AVAILABLE RANGE



## Turning cast iron pos "K20" insert

Insert	Designation	Grade	Chipbreaker	Material number	Available
	CCMT060204MRU	KP20C	...-MRU	11865626	●
	CCMT09T304MRU	KP20C		11821845	●
	CCMT09T308MRU	KP20C		11821847	●
	CCMT120408MRU	KP20C		11865627	●
	DCMT070204MRU	KP20C		11905454	●
	DCMT11T304MRU	KP20C		11821849	●
	DCMT11T308MRU	KP20C		11821857	●
	SCMT09T304MRU	KP20C		12001751	●
	SCMT09T308MRU	KP20C		11855086	●
	SCMT120408MRU	KP20C		11855089	●
	TCMT090204MRU	KP20C		11905457	●
	TCMT110204MRU	KP20C		11905458	●
	TCMT110208MRU	KP20C	11905456	●	
	TCMT16T304MRU	KP20C	11821858	●	
	TCMT16T308MRU	KP20C	11780842	●	

# CUTTING DATA -FU



General cutting parameters depending on the application

Work piece material	Type of treatment / alloy	Hardness HB	Uncoated carbide	
			NK15W	$v_c$ [m/min]
K	Cast iron	Grey cast iron	180	120-160
		Spheroidal	160	130-170
		Malleable/tempered iron	130	140-200
N	Alu Cuivre	Aluminium wrought alloys	100	100-2000
		Aluminium cast alloys	130	100-800
		Copper and copper alloys	90	100-600
		Non-metall materials	100	100-300
S	Exotic	Fe base	200	30-45
		Nickel or cobalt base	280	20-35
		Nickel or cobalt base	250	20-35
		Nickel or cobalt base	-	18-30
		Titanium	Rm 440*	60-120



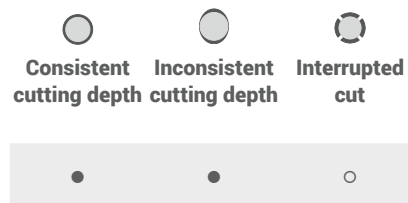

Application	Depth of cut / feed rate	
Chip groove	$a_p$ [mm]	$f$ [mm]
FU	1,5 to 6,5	0,20 to 0,50

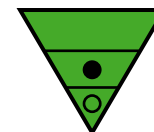

# AVAILABLE RANGE



## Turning non-ferrous pos "K15"

Insert	Designation	Grade	Chipbreaker	Material number	Available
	CCGT060201FU	NK15W	...	11818995	●
	CCGT060202FU	NK15W		11812686	●
	CCGT060204FU	NK15W		11796649	●
	CCGT09T302FU	NK15W		11812687	●
	CCGT09T304FU	NK15W		11559390	●
	CCGT09T308FU	NK15W		11587908	●
	CCGT120404FU	NK15W		11568607	●
	CCGT120408FU	NK15W		11796647	●
	DCGT070201FU	NK15W	...	11816442	●
	DCGT070202FU	NK15W		11780860	●
	DCGT070204FU	NK15W		11780861	●
	DCGT070208FU	NK15W		11782068	●
	DCGT11T302FU	NK15W		11818615	●
	DCGT11T304FU	NK15W		11568602	●
	DCGT11T308FU	NK15W		11780859	●
	SCGT09T304FU	NK15W	...	11879045	●
	SCGT09T308FU	NK15W		12042222	●
	TCGT110204FU	NK15W	...	12044373	●
	TCGT16T304FU	NK15W		12037327	●
	TCGT16T308FU	NK15W		12037326	●
	VCGT110302FU	NK15W	...	11815996	●
	VCGT110304FU	NK15W		11818617	●
	VCGT130302FU	NK15W		11816588	●
	VCGT130304FU	NK15W		11818611	●
	VCGT160404FU	NK15W		11556414	●
	VCGT160408FU	NK15W		11556416	●
	VCGT160412FU	NK15W		11556417	●
	VCGT220530FU	NK15W		12044457	●

# DOUBLE SIDED INSERTS





# CHIPBREAKER -WU

- ▲ WIPER Geometry
- ▲ High surface quality

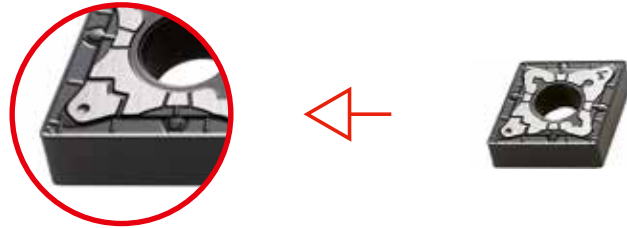

## CUTTING DATA

General cutting parameters depending on the application

Work piece material	Type of treatment / alloy	Hardness HB	Coated carbide			Application	Depth of cut / feed rate		
			P15C	P25C	P35C		Chip groove	$a_p$ [mm]	f [mm]
			$v_c$ [m/min]	$v_c$ [m/min]	$v_c$ [m/min]				
P	Non-alloyed steel 0–0.45% C	150-250	220-400	170-240	170-190	WU	0.50 to 3.00	0.15 to 0.35	
	Low-alloyed steel	250-300	200-320	100-190	90-150				
	High-alloyed steel	200	180-320	130-210	120-200				
	Corrosion-resistant steel	200	200-320	130-210	140-180				
M	Ferritic	200	220-320	140-210	140-200	Consistent cutting depth	Inconsistent cutting depth	Interrupted cut	
	Austenitic	180	-	100-210	110-190				
	Duplex	230-260	-	-	80-150				
	Martensitic	330	-	70-100	55-75				
K	Grey cast iron	180	140-370	130-210	-	Consistent cutting depth	Inconsistent cutting depth	Interrupted cut	
	Spheroidal	160	190-430	120-240	-				
	Malleable/tempered iron	130	180-520	150-250	-				

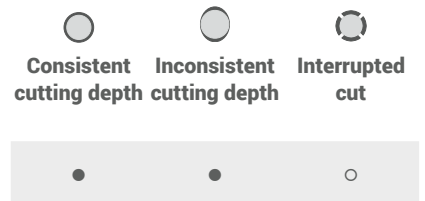

# AVAILABLE RANGE



WIPER

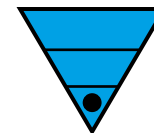

## Wiper turning steel neg "P15"

Insert	Designation	Grade	Chipbreaker	Material number	Available
	CNMX120404WU	P15C	...-WU	12078117	●
	CNMX120408WU	P15C		12078114	●
	DNMX150604WU	P15C		12078116	●
	DNMX150608WU	P15C		12078110	●
	WNMX080404WU	P15C		12078112	●
	WNMX080408WU	P15C		12078109	●

# OPERATING PRINCIPLE

## Improved surface finish

With the same feed rate an insert with Wiper cutting edge reaches a roughness value  $R_a$  which is many times higher than the one of a conventional insert.

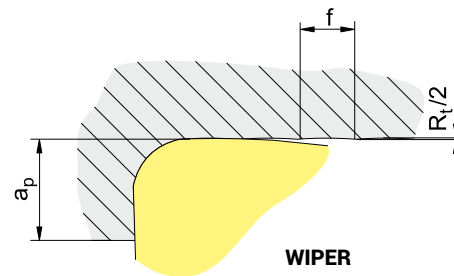
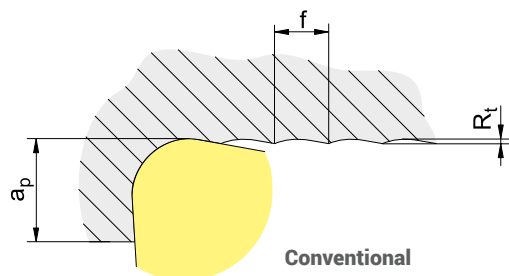

# CUTTING DATA -FC



## General cutting parameters depending on the application

Work piece material	Type of treatment / alloy	Hardness HB	Cermet
			PMH10T $v_c$ [m/min]
P	Steel		
	Non-alloyed steel 0-0.45% C	150-250	230-270
	Low-alloyed steel	250-300	180-230
	High-alloyed steel	200	160-200
M	Stainless steel		
	Ferritic	200	170-240
	Austenitic	180	200-240
	Duplex	230-260	-
K	Cast iron		
	Grey cast iron	180	-
	Spheroidal	160	220-300
	Malleable/tempered iron	130	250-350



Application	Depth of cut / feed rate	
	$a_p$ [mm]	$f$ [mm]
Chip groove		
FC	0.10 to 2.00	0.05 to 0.20

Consistent cutting depth	Inconsistent cutting depth	Interrupted cut
●	●	●
●	X	X

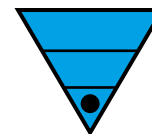
# AVAILABLE RANGE



## Turning steel neg finishing "CERMET"

Insert	Designation	Grade	Chipbreaker	Material number	Available
	CNMG120404FC	PMH10T	...-FC	11882894	●
	CNMG120408FC	PMH10T		11882895	●
	DNMG110404FC	PMH10T		11882708	●
	DNMG150604FC	PMH10T		11882698	●

# CHIPBREAKER -FU

- ▲ Increased life time
- ▲ Reduce temperature and stress

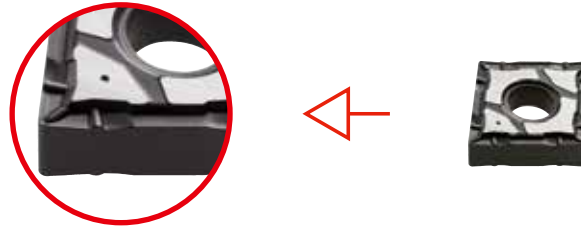

## CUTTING DATA

General cutting parameters depending on the application

Work piece material	Type of treatment / alloy	Hardness HB	Coated carbide			Application Chip groove	Depth of cut / feed rate	
			P15C	P25C	P35C		$a_p$ [mm]	f [mm]
			$v_c$ [m/min]	$v_c$ [m/min]	$v_c$ [m/min]			
P	Non-alloyed steel 0-0.45% C	150-250	220-400	170-240	170-190	FU	0.50 to 2.00	0.10 to 0.20
	Steel							
	Low-alloyed steel	250-300	200-320	100-190	90-150			
	High-alloyed steel	200	180-320	130-210	120-200			
M	Corrosion-resistant steel	200	200-320	130-210	140-180			
	Stainless steel							
	Ferritic	200	220-320	140-210	140-200			
	Austenitic	180	-	100-210	110-190			
K	Duplex	230-260	-	-	80-150			
	Martensitic	330	-	70-100	55-75			
	Cast iron							
	Grey cast iron	180	-	-	-			
	Spheroidal	160	-	-	-			
	Malleable/tempered iron	130	-	-	-			

Consistent cutting depth	Inconsistent cutting depth	Interrupted cut
●	○	X

# AVAILABLE RANGE

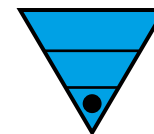

## Heavy turning steel neg "P15"

Insert	Designation	Grade	Chipbreaker	Material number	Available
	CNMG090304FU	P15C	...-FU	12044441	●
	CNMG120404FU	P15C		12044444	●
	CNMG120408FU	P15C		12044454	●
	DNMG110404FU	P15C		12041499	●
	DNMG150604FU	P15C		12041505	●
	DNMG150608FU	P15C		12067233	●
	VNMG160404FU	P15C		12046214	●
	WNMG060404FU	P15C		12046215	●
	WNMG080404FU	P15C		12046216	●

## Heavy turning steel neg "P25"

Insert	Designation	Grade	Chipbreaker	Material number	Available
	CNMG120404FU	P25C	...-FU	12044450	●
	CNMG120408FU	P25C		12044455	●
	DNMG110404FU	P25C		12041502	●

# CUTTING DATA -MRU



## General cutting parameters depending on the application

Work piece material	Type of treatment / alloy	Hardness HB	Coated carbide			Application	Depth of cut / feed rate	
			P15C $v_c$ [m/min]	P25C $v_c$ [m/min]	P35C $v_c$ [m/min]		Chip groove	$a_p$ [mm]
P	Non-alloyed steel 0-0.45% C	150-250	220-400	170-240	170-190	MRU	1.00 to 4.00	0.22 to 0.40
	Steel							
	Low-alloyed steel	250-300	200-320	100-190	90-150			
	High-alloyed steel	200	180-320	130-210	120-200			
M	Corrosion-resistant steel	200	200-320	130-210	140-180			
	Stainless steel							
	Ferritic	200	220-320	140-210	140-200			
	Austenitic	180	-	100-210	110-190			
K	Duplex	230-260	-	-	80-150			
	Martensitic	330	-	70-100	55-75			
	Cast iron							
	Grey cast iron	180	140-370	130-210	-			
K	Spheroidal	160	190-430	120-240	-			
	Malleable/tempered iron	130	180-520	150-250	-			

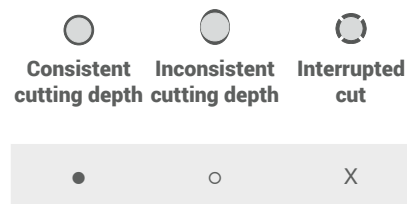





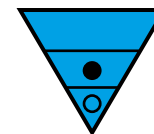



# AVAILABLE RANGE



## Turning steel neg semi finishing "P15"

Insert	Designation	Grade	Chipbreaker	Material number	Available
	CNMG120404MRU	P15C		11854331	●
	CNMG120408MRU	P15C		11854338	●
	CNMG120412MRU	P15C		11861944	●
	DNMG110404MRU	P15C		12067234	●
	DNMG110408MRU	P15C		12032128	●
	DNMG150604MRU	P15C		11855030	●
	DNMG150608MRU	P15C		11855070	●
	DNMG150612MRU	P15C		11861919	●
	SNMG120408MRU	P15C		11861932	●
	SNMG120412MRU	P15C		11861936	●
	TNMG160404MRU	P15C	...-MRU	11861915	●
	TNMG160408MRU	P15C		11861899	●
	TNMG160412MRU	P15C		11861913	●
	VNMG160404MRU	P15C		11861933	●
	VNMG160408MRU	P15C		11861935	●
	WNMG060404MRU	P15C		11861939	●
	WNMG060408MRU	P15C		11861942	●
	WNMG080404MRU	P15C		11855139	●
	WNMG080408MRU	P15C		11855141	●
	WNMG080412MRU	P15C		11861917	●

# CUTTING DATA -MRU



## General cutting parameters depending on the application

Work piece material	Type of treatment / alloy	Hardness HB	Coated carbide			Application	Depth of cut / feed rate	
			P15C $v_c$ [m/min]	P25C $v_c$ [m/min]	P35C $v_c$ [m/min]		Chip groove	$a_p$ [mm]
P	Non-alloyed steel 0-0.45% C	150-250	220-400	170-240	170-190	MRU	1.00 to 4.00	0.22 to 0.44
	Steel							
	Low-alloyed steel	250-300	200-320	100-190	90-150			
	High-alloyed steel	200	180-320	130-210	120-200			
M	Corrosion-resistant steel	200	200-320	130-210	140-180			
	Stainless steel							
	Ferritic	200	220-320	140-210	140-200			
	Austenitic	180	-	100-210	110-190			
K	Duplex	230-260	-	-	80-150			
	Martensitic	330	-	70-100	55-75			
	Cast iron							
	Grey cast iron	180	140-370	130-210	-			
K	Spheroidal	160	190-430	120-240	-			
	Malleable/tempered iron	130	180-520	150-250	-			

  

<b>Consistent cutting depth</b>	<b>Inconsistent cutting depth</b>	<b>Interrupted cut</b>

--	--	--

# AVAILABLE RANGE

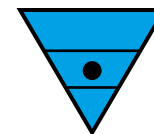

## Turning steel neg medium roughing "P25"

Insert	Designation	Grade	Chipbreaker	Material number	Available	
	CNMG120404MRU	P25C		11562085	●	
	CNMG120408MRU	P25C		11557291	●	
	DNMG110404MRU	P25C		11577562	●	
	DNMG110408MRU	P25C		11562091	●	
	DNMG150404MRU	P25C		11562093	●	
	DNMG150408MRU	P25C		11752699	●	
	DNMG150604MRU	P25C		11752701	●	
	DNMG150608MRU	P25C		11562094	●	
	DNMG150612MRU	P25C		11562097	●	
	DNMG150612MRU	P25C		11581880	●	
	SNMG120408MRU	P25C		11560890	●	
	SNMG120412MRU	P25C		11579855	●	
	TNMG160404MRU	P25C		...-MRU	11562100	●
	TNMG160408MRU	P25C		11557290	●	
	TNMG160412MRU	P25C		11581881	●	
	TNMG220404MRU	P25C		11562102	●	
	TNMG220408MRU	P25C	11562105	●		
	VNMG160404MRU	P25C	11562107	●		
	VNMG160408MRU	P25C	11560889	●		
	WNMG060404MRU	P25C	11562108	●		
	WNMG060408MRU	P25C	11562111	●		
	WNMG080404MRU	P25C	11562112	●		
	WNMG080408MRU	P25C	11560888	●		
	WNMG080412MRU	P25C	11577559	●		

# CUTTING DATA -MRU



## General cutting parameters depending on the application



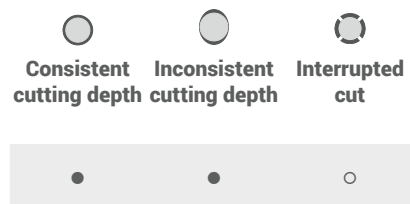

Work piece material	Type of treatment / alloy	Hardness HB	P25CX $v_c$ [m/min]
P	Steel		
	Non-alloyed steel 0-0.45% C	150-250	170-240
	Low-alloyed steel	250-300	100-190
	High-alloyed steel	200	130-210
M	Stainless steel		
	Ferritic	200	140-210
	Austenitic	180	100-210
	Duplex	230-260	-
K	Cast iron		
	Grey cast iron	180	130-210
	Spheroidal	160	120-240
	Malleable/tempered iron	130	150-250

Application	Depth of cut / feed rate	
Chip groove	$a_p$ [mm]	$f$ [mm]
MRU	1.00 to 4.00	0.22 to 0.44

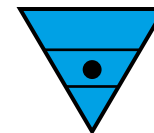

# AVAILABLE RANGE



Insert	Designation	Grade	Chipbreaker	Material number	Available
	CNMG120408MRU	P25CX	...-MRU	12245949	●
	CNMG120412MRU	P25CX		12245954	●
	DNMG150608MRU	P25CX		12245956	●
	TNMG160408MRU	P25CX		12245955	●
	SNMG120408MRU	P25CX		12245950	●
	WNMG080408MRU	P25CX		12245952	●
	WNMG080412MRU	P25CX		12245953	●

# CUTTING DATA -MRU





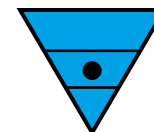

## General cutting parameters depending on the application

Work piece material	Type of treatment / alloy	Hardness HB	Coated carbide			Application	Depth of cut / feed rate	
			P15C $v_c$ [m/min]	P25C $v_c$ [m/min]	P35C $v_c$ [m/min]		Chip groove	$a_p$ [mm]
P	Non-alloyed steel 0-0.45% C	150-250	220-400	170-240	170-190	MRU	1.00 to 4.00	0.22 to 0.44
	Low-alloyed steel	250-300	200-320	100-190	90-150			
	High-alloyed steel	200	180-320	130-210	120-200			
	Corrosion-resistant steel	200	200-320	130-210	140-180			
M	Ferritic	200	220-320	140-210	140-200	 Consistent cutting depth	 Inconsistent cutting depth	 Interrupted cut
	Austenitic	180	-	100-210	110-190			
	Duplex	230-260	-	-	80-150			
	Martensitic	330	-	70-100	55-75			
K	Grey cast iron	180	140-370	130-210	-	 Consistent cutting depth	 Inconsistent cutting depth	 Interrupted cut
	Spheroidal cast iron	160	190-430	120-240	-			
	Malleable/tempered iron	130	180-520	150-250	-			

# AVAILABLE RANGE



## Turning steel neg medium roughing "P35"

Insert	Designation	Grade	Chipbreaker	Material number	Available
	CNMG120408MRU	P35C		11854341	●
	CNMG120412MRU	P35C		11854345	●
	DNMG110408MRU	P35C		12032130	●
	DNMG150608MRU	P35C		11855074	●
	DNMG150612MRU	P35C		11855076	●
	SNMG120408MRU	P35C	...-MRU	11855100	●
	SNMG120412MRU	P35C		11855103	●
	TNMG160408MRU	P35C		11855128	●
	WNMG080408MRU	P35C		11855143	●
	WNMG080412MRU	P35C		11855145	●

# CUTTING DATA -RU



## General cutting parameters depending on the application

Work piece material	Type of treatment / alloy	Hardness HB	Coated carbide			Application	Depth of cut / feed rate	
			P15C $v_c$ [m/min]	P25C $v_c$ [m/min]	P35C $v_c$ [m/min]		Chip groove	$a_p$ [mm]
P	Non-alloyed steel 0-0.45% C	150-250	220-400	170-240	170-190	RU	1.50 to 5.00	0.30 to 0.50
	Steel							
	Low-alloyed steel	250-300	200-320	100-190	90-150			
	High-alloyed steel	200	180-320	130-210	120-200			
M	Corrosion-resistant steel	200	200-320	130-210	140-180			
	Stainless steel							
	Ferritic	200	220-320	140-210	140-200			
	Austenitic	180	-	100-210	110-190			
K	Duplex	230-260	-	-	80-150			
	Martensitic	330	-	70-100	55-75			
	Cast iron							
K	Grey cast iron	180	140-370	130-210	-			
	Spheroidal	160	190-430	120-240	-			
	Malleable/tempered iron	130	180-520	150-250	-			

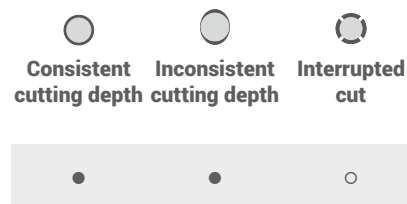



# AVAILABLE RANGE

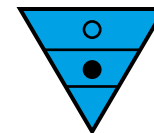

## Turning steel neg roughing "P15"

Insert	Designation	Grade	Chipbreaker	Material number	Available
	CNMG120408RU	P15C	...-RU	11983084	●
	DNMG150608RU	P15C		12037321	●
	DNMG150612RU	P15C		12048929	●

## Turning steel neg roughing "P25"

Insert	Designation	Grade	Chipbreaker	Material number	Available
	CNMG120408RU	P25C	...-RU	11882916	●
	CNMG120412RU	P25C		11882915	●
	DNMG150608RU	P25C	...-RU	12037320	●
	DNMG150612RU	P25C		12049239	●
	SNMG120408RU	P25C	...-RU	11882913	●
	SNMG120412RU	P25C		11882911	●
	TNMG160408RU	P25C	...-RU	11882909	●
	TNMG160412RU	P25C		11882907	●
	WNMG080408RU	P25C	...-RU	11882906	●
	WNMG080412RU	P25C		11882904	●

## Turning steel neg roughing "P35"

Insert	Designation	Grade	Chipbreaker	Material number	Available
	DNMG150608RU	P35C	...-RU	12037319	●
	DNMG150612RU	P35C		12049240	●

# CUTTING DATA -FM



## General cutting parameters depending on the application

Work piece material	Type of treatment / alloy	Hardness HB	Coated carbide	
			MK20P	$v_c$ [m/min]
M	Stainless steel	Ferritic	200	150-200
		Austenitic	180	120-200
		Duplex	230-260	90-160
		Martensitic	330	60-80
K	Cast iron	Grey cast iron	180	120-160
		Spheroidal	160	120-160
		Malleable/tempered iron	130	140-220
N	Non-ferrous		100	100-400
			130	100-400
			90	100-600
			100	100-400
S	Exotic	Fe base	200	20-50
		Nickel or Kobalt base	280	20-50
		Nickel or Kobalt base	250	15-40
		Nickel or Kobalt base		20-35
		Titanium	Rm 440*	80-140

Application	Depth of cut / feed rate	
	$a_p$ [mm]	$f$ [mm]
Chip groove		
FM	0.5 to 2.5	0.10 to 0.25

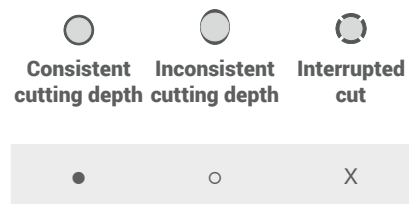

# AVAILABLE RANGE

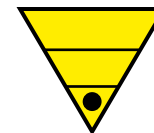

Turning stainless steel neg finishing "M25"

Insert	Designation	Grade	Chipbreaker	Material number	Available
	CNGP120402FM	MK20P	...FM	11223927	●
	CNGP120404FM	MK20P		11219251	●
	CNGP120408FM	MK20P		11219254	●
	CNGP120412FM	MK20P		12068756	●
	DNGP150404FM	MK20P	...FM	11219260	●
	DNGP150602FM	MK20P		11241911	●
	DNGP150604FM	MK20P		11241912	●
	DNGP150608FM	MK20P		11226180	●
	VNGP160402FM	MK20P	...FM	11215526	●
	VNGP160404FM	MK20P		11226182	●
	WNGP080404FM	MK20P	...FM	11225022	●
	WNGP080408FM	MK20P		11220363	●

# CHIPBREAKER -MM

## Sharp positive cutting edges:

- ▲ Reduced formation of burrs
- ▲ Good surface finish
- ▲ Low cutting forces

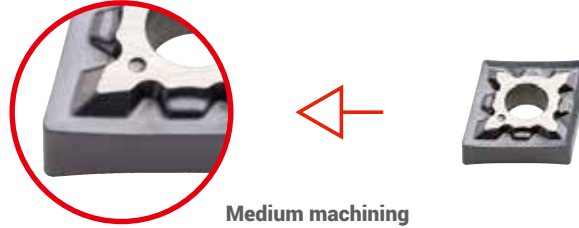

# CUTTING DATA

## General cutting parameters depending on the application

Work piece material	Type of treatment / alloy	Hardness HB	Coated carbide	
			PMS25P	MP35P
			$v_c$ [m/min]	$v_c$ [m/min]
P	Non-alloyed steel 0-0.45% C	150-250	130-250	170-190
	Low-alloyed steel	250-300	60-180	90-150
	High-alloyed steel	200	80-200	120-200
	Corrosion-resistant steel	200	100-200	140-180
M	Ferritic	200	120-250	140-200
	Austenitic	180	100-220	110-190
	Duplex	230-260	60-160	80-150
	Martensitic	330	40-100	55-75

Application	Depth of cut / feed rate	
Chip groove	$a_p$ [mm]	$f$ [mm]
MM	1.00 to 4.20	0.22 to 0.40

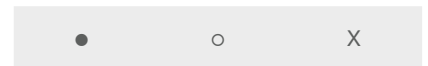

# AVAILABLE RANGE

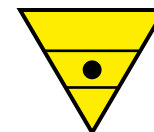

## Turning stainless steel neg medium "M25"

Insert	Designation	Grade	Chipbreaker	Material number	Available
	CNMG090304MM	PMS25P		11812968	●
	CNMG090308MM	PMS25P		11812211	●
	CNMG120404MM	PMS25P		11748122	●
	CNMG120408MM	PMS25P		11748123	●
	DNMG110404MM	PMS25P		11808002	●
	DNMG110408MM	PMS25P		11807993	●
	DNMG150404MM	PMS25P		11753922	●
	DNMG150408MM	PMS25P		11753921	●
	DNMG150604MM	PMS25P		11748133	●
	DNMG150608MM	PMS25P		11748134	●
	SNMG120408MM	PMS25P	...-MM	11804482	●
	TNMG160404MM	PMS25P		11748628	●
	TNMG160408MM	PMS25P		11748632	●
	VNMG160408MM	PMS25P		11754890	●
	WNMG060404MM	PMS25P		11808488	●
	WNMG060408MM	PMS25P		11808489	●
	WNMG080404MM	PMS25P		11749341	●
	WNMG080408MM	PMS25P		11749343	●
	WNMG080412MM	PMS25P		11808490	●

# CHIPBREAKER -MM

## Sharp positive cutting edges:

- ▲ Reduced formation of burrs
- ▲ Good surface finish
- ▲ Low cutting forces

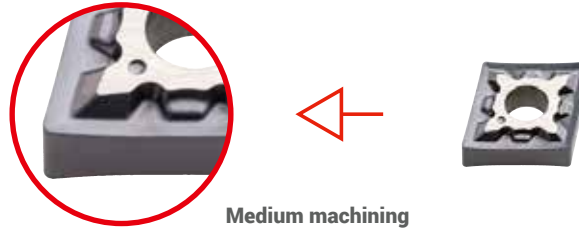

# CUTTING DATA

## General cutting parameters depending on the application

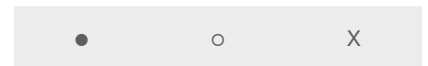

Work piece material	Type of treatment / alloy	Hardness HB	Coated carbide	
			M20CX	$v_c$ [m/min]
P	Non-alloyed steel 0-0.45% C	150-250	130-250	
	Low-alloyed steel	250-300	60-180	
	High-alloyed steel	200	80-200	
	Corrosion-resistant steel	200	100-200	
M	Ferritic	200	120-250	
	Austenitic	180	120-220	
	Duplex	230-260	-	
	Martensitic	330	-	

Application	Depth of cut / feed rate	
	$a_p$ [mm]	$f$ [mm]
Chip groove		
MM	1.00 to 4.20	0.22 to 0.40

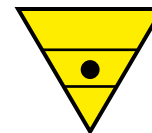

# AVAILABLE RANGE



Insert	Designation	Grade	Chipbreaker	Material number	Available
	CNMG120404MM	M20CX	...-MM	12233866	●
	CNMG120408MM	M20CX		12233867	●
	DNMG150604MM	M20CX		12233869	●
	DNMG150608MM	M20CX		12233868	●
	WNMG080404MM	M20CX		12233872	●
	WNMG080408MM	M20CX		12233870	●

# CHIPBREAKER -RM

## Sharp positive cutting edges:

- ▲ Reduced formation of burrs
- ▲ Good surface finish
- ▲ Low cutting forces

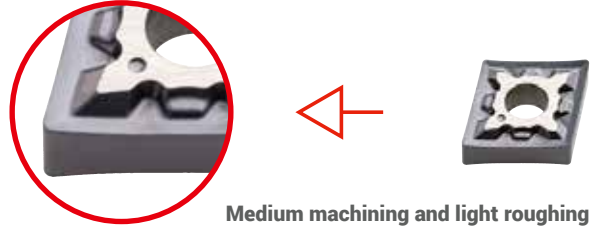

# CUTTING DATA

## General cutting parameters depending on the application

Work piece material	Type of treatment / alloy	Hardness HB	Coated carbide	
			PMS25P	MP35P
			$v_c$ [m/min]	$v_c$ [m/min]
P	Non-alloyed steel 0-0.45% C	150-250	130-250	170-190
	Low-alloyed steel	250-300	60-180	90-150
	High-alloyed steel	200	80-200	120-200
	Corrosion-resistant steel	200	100-200	140-180
M	Ferritic	200	120-250	140-200
	Austenitic	180	100-220	110-190
	Duplex	230-260	60-160	80-150
	Martensitic	330	40-100	55-75

Application	Depth of cut / feed rate	
Chip groove	$a_p$ [mm]	$f$ [mm]
RM	1.50 to 6.00	0.25 to 0.50





# AVAILABLE RANGE

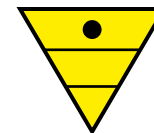

## Turning stainless steel neg roughing "M25"

Insert	Designation	Grade	Chipbreaker	Material number	Available
	CNMG120408RM	PMS25P	...-RM	11752697	●
	CNMG120412RM	PMS25P		11752698	●
	DNMG150608RM	PMS25P		11752693	●
	DNMG150612RM	PMS25P		11752691	●
	TNMG160408RM	PMS25P		11752690	●
	TNMG160412RM	PMS25P		11752688	
	WNMG080408RM	PMS25P		11752687	●
	WNMG080412RM	PMS25P		11752685	●

# CUTTING DATA -MRU



## General cutting parameters depending on the application

Work piece material	Type of treatment / alloy	Hardness HB	Coated carbide	
			KP20C	$v_c$ [m/min]
P Steel	Non-alloyed steel 0-0.45% C	150-250	200-340	
	Low-alloyed steel	250-300	150-290	
	High-alloyed steel	200	150-290	
	Corrosion-resistant steel	200	160-290	
K Cast iron	Grey cast iron	180	150-400	
	Spheroidal	160	200-450	
	Malleable/tempered iron	130	200-550	

Application	Depth of cut / feed rate		
	$a_p$ [mm]	$f$ [mm]	
Chip groove MRU	1.00 to 4.00	0.22 to 0.44	
	 <b>Consistent cutting depth</b>	 <b>Inconsistent cutting depth</b>	 <b>Interrupted cut</b>
	●	○	X

# AVAILABLE RANGE

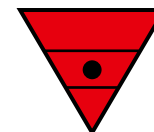

## Turning cast iron neg "K20"

Insert	Designation	Grade	Chipbreaker	Material number	Available
	CNMG120408MRU	KP20C	...	11780521	●
	CNMG120412MRU	KP20C		11865623	●
	DNMG150608MRU	KP20C		11780519	●
	DNMG150612MRU	KP20C		11780518	●
	SNMG120408MRU	KP20C		11911053	●
				...	
	TNMG160408MRU	KP20C		11780838	●
	TNMG160412MRU	KP20C		11865634	●
	TNMG220408MRU	KP20C		11780836	●
	WNMG080408MRU	KP20C		11780839	●
	WNMG080412MRU	KP20C		11780841	●

# CUTTING DATA - RPK



## General cutting parameters depending on the application

Work piece material	Type of treatment / alloy	Hardness HB	Coated carbide	
			KP20C	$v_c$ [m/min]
P	Non-alloyed steel 0-0.45% C	150-250		200 -340
	Low-alloyed steel	250-300		150-290
	High-alloyed steel	200		150-290
	Corrosion-resistant steel	200		160-290
K	Grey cast iron	180		150-400
	Spheroidal	160		200-450
	Malleable/tempered iron	130		200-550

Application	Depth of cut / feed rate			
	$a_p$ [mm]	$f$ [mm]		
Chip groove				
RPK	2.00 to 4.80	0.30 to 0.48		
	Consistent cutting depth	Inconsistent cutting depth	Interrupted cut	Interrupted cut
	•	•	X	Only $\overset{\circ}{\circ}$ .NMA

# AVAILABLE RANGE

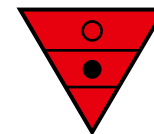

## Turning cast iron neg "K20"

Insert	Designation	Grade	Chipbreaker	Material number	Available
	CNMG120408RPK	KP20C	...-RPK	11821829	●
	CNMG120412RPK	KP20C		11821831	●
	CNMG160612RPK	KP20C		11781440	●
	DNMG150608RPK	KP20C		11821833	●
	SNMG120408RPK	KP20C		11821834	●
	TNMG160408RPK	KP20C		11875228	●
	WNMG080408RPK	KP20C		11875227	●
	WNMG080412RPK	KP20C	11875229	●	
	CNMA120408	KP20C	11821837	●	
	CNMA120412	KP20C	11931076	●	
			11946726	●	
	SNMA120408	KP20C	11821838	●	
	TNMA160408	KP20C	11821839	●	
	WNMA080408	KP20C	11821840	●	

# CUTTING DATA - RPK



## General cutting parameters depending on the application

Work piece material	Type of treatment / alloy	Hardness HB	Coated carbide	
			K10CX	$v_c$ [m/min]
P	Non-alloyed steel 0-0.45% C	150-250	220-400	
	Low-alloyed steel	250-300	170-340	
	High-alloyed steel	200	170-340	
	Corrosion-resistant steel	200	200-300	
K	Grey cast iron	180	170-450	
	Spheroidal	160	220-430	
	Malleable/tempered iron	130	220-400	

Application	Depth of cut / feed rate			
	$a_p$ [mm]	$f$ [mm]		
Chip groove				
RPK	2.0 to 4.8	0.30 to 0.48		
	Consistent cutting depth	Inconsistent cutting depth	Interrupted cut	Interrupted cut
	•	•	X	Only $\overset{\circ}{\circ}$ .NMA

# AVAILABLE RANGE

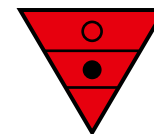

Insert	Designation	Grade	Chipbreaker	Material number	Available
	CNMG120408RPK	K10CX	...-RPK	12149710	●
	CNMG120412RPK	K10CX		12200956	●
	CNMG160612RPK	K10CX		12200958	●
	SNMG120412RPK	K10CX		12200959	●
		WNMG080408RPK		K10CX	12200960
WNMG080412RPK		K10CX		12200954	●
	CNMA120408	K10CX	12234327	●	
	WNMA080412	K10CX	12234328	●	

# CUTTING DATA -FS



General cutting parameters depending on the application

Work piece material	Type of treatment / alloy	Coated carbide SM10P	
		Hardness HB	$v_c$ [m/min]
M	Stainless steel		
	Ferritic	200	150-230
	Austenitic	180	140-190
	Duplex	230-260	60-100
	Martensitic	330	-
S	Exotic		
	Fe base	200	80-120
	Nickel or Kobalt base	280	60-100
	Nickel or Kobalt base	250	35-90
	Nickel or Kobalt base		30-50
	Titanium	Rm 440*	70-120

Application	Depth of cut / feed rate	
	$a_p$ [mm]	$f$ [mm]
Chip groove FS	0.80 to 3.00	0.10 to 0.30





**Consistent cutting depth**    **Inconsistent cutting depth**    **Interrupted cut**

●	○	X
---	---	---



# AVAILABLE RANGE

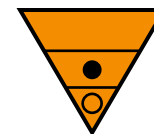

## Turning titanium "S10"

Insert	Designation	Grade	Chipbreaker	Material number	Available
	CNMG120404FS	SM10P	...-FS	11750288	●
	CNMG120408FS	SM10P		11749057	●
	DNMG150608FS	SM10P		11749060	●
	SNMG120408FS	SM10P		11748599	●
	TNMG160408FS	SM10P		11748631	●
	VNMG160408FS	SM10P		11749297	●
	WNMG080408FS	SM10P	11749342	●	

# CUTTING DATA -FS



General cutting parameters depending on the application

Work piece material	Type of treatment / alloy	Coated carbide S15P	
		Hardness HB	$v_c$ [m/min]
M	Ferritic	200	130-220
	Austenitic	180	120-80
	Duplex	230-260	50-90
	Martensitic	330	-
S	Fe base	200	80-120
	Nickel or Kobalt base	280	60-100
	Nickel or Kobalt base	250	35-90
	Nickel or Kobalt base		30-50
	Titanium	Rm 440*	70-120

Application	Depth of cut / feed rate	
	$a_p$ [mm]	$f$ [mm]
Chip groove FS	0.80 to 3.00	0.10 to 0.30



  
**Consistent cutting depth**    **Inconsistent cutting depth**    **Interrupted cut**

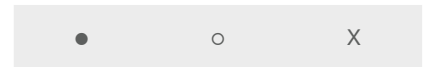

# AVAILABLE RANGE

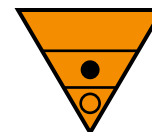

## Turning titanium "S15"

Insert	Designation	Grade	Chipbreaker	Material number	Available
	CNMG120404FS	S15P	...-FS	11750290	●
	CNMG120408FS	S15P		11568115	●
	DNMG150608FS	S15P		11568117	●
	SNMG120408FS	S15P		11568120	●
					●
	TNMG160408FS	S15P		11568121	●
	VNMG160408FS	S15P	11568122	●	
	WNMG080408FS	S15P	11568123	●	

# HEAVY DUTY TURNING



# CUTTING DATA -STC



General cutting parameters depending on the application

Work piece material	Type of treatment / alloy	Hardness HB	Coated carbide			Application	Depth of cut / feed rate	
			P15C $v_c$ [m/min]	P25C $v_c$ [m/min]	P35C $v_c$ [m/min]		Chip groove	$a_p$ [mm]
P	Non-alloyed steel 0-0.45% C	150-250	220-400	170-240	170-190	STC	2.50 to 10.0	0.30 to 0.60
	Steel							
	Low-alloyed steel	250-300	200-320	100-190	90-150			
	High-alloyed steel	200	180-320	130-210	120-200			
M	Corrosion-resistant steel	200	200-320	130-210	140-180			
	Stainless steel							
	Ferritic	200	220-320	140-210	140-200			
	Austenitic	180	-	100-210	110-190			
K	Duplex	230-260	-	-	80-150			
	Martensitic	330	-	70-100	55-75			
	Cast iron							
K	Grey cast iron	180	140-370	130-210	-			
	Spheroidal	160	190-430	120-240	-			
	Malleable/tempered iron	130	180-520	150-250	-			

  

<b>Consistent cutting depth</b>	<b>Inconsistent cutting depth</b>	<b>Interrupted cut</b>

  

--	--	--

# AVAILABLE RANGE

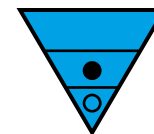

## Heavy turning steel neg "P25"

Insert	Designation	Grade	Chipbreaker	Material number	Available
	SNMM190616STC	P25C	...-STC	11849212	●
	SNMM250924STC	P25C		11849211	●

# CHIPBREAKER -R1

## Sharp positive cutting edges:

- ▲ Single-sided roughing geometry
- ▲ Good chip control
- ▲ For steels with high strength (800 N/mm<sup>2</sup>)

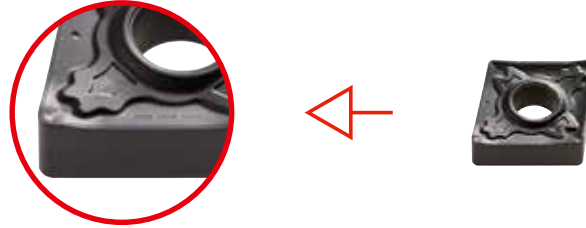

## CUTTING DATA

### General cutting parameters depending on the application

Work piece material	Type of treatment / alloy	Hardness HB	Coated carbide			Application	Depth of cut / feed rate	
			P15C v <sub>c</sub> [m/min]	P25C v <sub>c</sub> [m/min]	P35C v <sub>c</sub> [m/min]		Chip groove	a <sub>p</sub> [mm]
P	Non-alloyed steel 0-0.45% C	150-250	220-400	170-240	170-190	R1	1.50 to 12.0	0.50 to 0.90
	Steel							
	Low-alloyed steel	250-300	200-320	100-190	90-150			
	High-alloyed steel	200	180-320	130-210	120-200			
	Corrosion-resistant steel	200	200-320	130-210	140-180			
M	Stainless steel							
	Ferritic	200	220-320	140-210	140-200			
	Austenitic	180	-	100-210	110-190			
	Duplex	230-260	-	-	80-150			
	Martensitic	330	-	70-100	55-75			
K	Cast iron							
	Grey cast iron	180	140-370	130-210	-			
	Spheroidal	160	190-430	120-240	-			
	Malleable/tempered iron	130	180-520	150-250	-			

<b>Consistent cutting depth</b>	<b>Inconsistent cutting depth</b>	<b>Interrupted cut</b>



# AVAILABLE RANGE

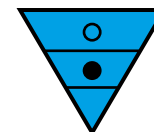

## Heavy turning steel neg "P15"

Insert	Designation	Grade	Chipbreaker	Material number	Available
	CNMM120408R1	P15C	...R1	12041787	●
	DNMM150608R1	P15C		12055337	●

## Heavy turning steel neg "P25"

Insert	Designation	Grade	Chipbreaker	Material number	Available
	CNMM120408R1	P25C	...R1	12041513	●
	CNMM120412R1	P25C			12077416
	DNMM150608R1	P25C		12055332	●

## Heavy turning steel neg "P35"

Insert	Designation	Grade	Chipbreaker	Material number	Available
	CNMM120408R1	P35C	...R1	12041518	●
	DNMM150608R1	P35C		12055326	●

# CUTTING DATA -R2



General cutting parameters depending on the application

Work piece material	Type of treatment / alloy	Hardness HB	Coated carbide			Application	Depth of cut / feed rate	
			P15C $v_c$ [m/min]	P25C $v_c$ [m/min]	P35C $v_c$ [m/min]		Chip groove	$a_p$ [mm]
P	Non-alloyed steel 0-0.45% C	150-250	220-400	170-240	170-190	R2	2.00 to 12.0	0.30 to 0.80
	Steel							
	Low-alloyed steel	250-300	200-320	100-190	90-150			
	High-alloyed steel	200	180-320	130-210	120-200			
M	Corrosion-resistant steel	200	200-320	130-210	140-180			
	Stainless steel							
	Ferritic	200	220-320	140-210	140-200			
	Austenitic	180	-	100-210	110-190			
K	Duplex	230-260	-	-	80-150			
	Martensitic	330	-	70-100	55-75			
	Cast iron							
Grey cast iron	180	140-370	130-210	-				
Spheroidal	160	190-430	120-240	-				
Malleable/tempered iron	130	180-520	150-250	-				

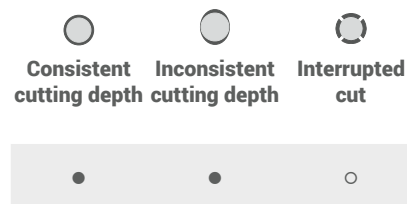

# AVAILABLE RANGE

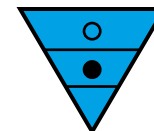

## Heavy turning steel neg "P15"

Insert	Designation	Grade	Chipbreaker	Material number	Available
	CNMM120412R2	P15C	...-R2	12046218	●
	CNMM160612R2	P15C		12044415	●
	CNMM190612R2	P15C		12030570	●
	DNMM150612R2	P15C		12044385	●

## Heavy turning steel neg "P25"

Insert	Designation	Grade	Chipbreaker	Material number	Available
	CNMM120412R2	P25C	...-R2	12046217	●
	CNMM120416R2	P25C		12044382	●
	CNMM160612R2	P25C		12044410	●
	CNMM190612R2	P25C		11840692	●
	CNMM190616R2	P25C		11836430	●
	CNMM250724R2	P25C		11848028	●
	CNMM250924R2	P25C		11840037	●
	DNMM150612R2	P25C		12044390	●
	SNMM190612R2	P25C	11840041	●	
	SNMM190616R2	P25C	11840042	●	
	SNMM250724R2	P25C	11840045	●	
	SNMM250924R2	P25C	11840046	●	

## Heavy turning steel neg "P35"

Insert	Designation	Grade	Chipbreaker	Material number	Available
	CNMM120412R2	P35C	...-R2	12046219	●
	CNMM120416R2	P35C		12044397	●
	CNMM160612R2	P35C		12044423	●
	DNMM150612R2	P35C		12044431	●

# CUTTING DATA -R3



## General cutting parameters depending on the application

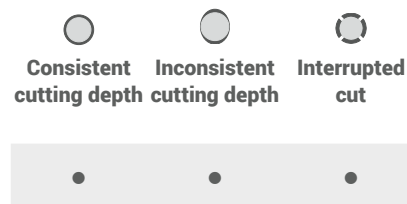

Work piece material	Type of treatment / alloy	Hardness HB	Coated carbide			Application	Depth of cut / feed rate	
			P15C $v_c$ [m/min]	P25C $v_c$ [m/min]	P35C $v_c$ [m/min]		Chip groove	$a_p$ [mm]
P	Non-alloyed steel 0-0.45% C	150-250	220-400	170-240	170-190	R3	2.50 to 12.0	0.35 to 1.20
	Steel							
	Low-alloyed steel	250-300	200-320	100-190	90-150			
	High-alloyed steel	200	180-320	130-210	120-200			
M	Corrosion-resistant steel	200	200-320	130-210	140-180			
	Stainless steel							
	Ferritic	200	220-320	140-210	140-200			
	Austenitic	180	-	100-210	110-190			
K	Duplex	230-260	-	-	80-150			
	Martensitic	330	-	70-100	55-75			
	Cast iron							
K	Grey cast iron	180	140-370	130-210	-			
	Spheroidal	160	190-430	120-240	-			
	Malleable/tempered iron	130	180-520	150-250	-			

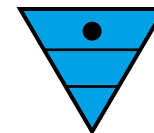

# AVAILABLE RANGE



## Heavy turning steel neg "P25"

Insert	Designation	Grade	Chipbreaker	Material number	Available
	CNMM190616R3	P25C	...R3	11840034	●
	CNMM190624R3	P25C		11840035	●
	CNMM250924R3	P25C		11840038	●
	CNMM250932R3	P25C		11840039	●
	SNMM190616R3	P25C		11840043	●
	SNMM190624R3	P25C		11840044	●
	SNMM250924R3	P25C		11840047	●
	SNMM250932R3	P25C		11840048	●

# CUTTING DATA - RPK



## General cutting parameters depending on the application

Work piece material	Type of treatment / alloy	Hardness HB	P15C	P25C	P35C	Application	Depth of cut / feed rate	
			$v_c$ [m/min]	$v_c$ [m/min]	$v_c$ [m/min]		Chip groove	$a_p$ [mm]
P	Non-alloyed steel 0-0.45% C	150-250	220-400	170-240	170-190	RPK	3.20 to 7.60	0.60 to 1.00
	Low-alloyed steel	250-300	200-320	100-190	90-150			
	High-alloyed steel	200	180-320	130-210	120-200			
	Corrosion-resistant steel	200	200-320	130-210	140-180			
M	Ferritic	200	220-320	140-210	140-200	Consistent cutting depth	Inconsistent cutting depth	Interrupted cut
	Austenitic	180	-	100-210	110-190			
	Duplex	230-260	-	-	80-150			
	Martensitic	330	-	70-100	55-75			
K	Grey cast iron	180	140-370	130-210	-	Consistent cutting depth	Inconsistent cutting depth	Interrupted cut
	Spheroidal	160	190-430	120-240	-			
	Malleable/tempered iron	130	180-520	150-250	-			

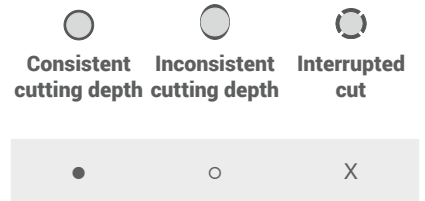

# AVAILABLE RANGE

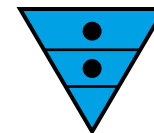

## Medium and roughing turning steel

Insert	Designation	Grade	Chipbreaker	Material number	Available
	CNMG160612RPK	P25C		11854347	●
	CNMG190612RPK	P25C		11854749	●
	CNMG190616RPK	P25C		11625891	●
	SNMG150612RPK	P25C	...-RPK	11855109	●
	SNMG190612RPK	P25C		11855114	●
	TNMG220412RPK	P25C		11860512	●
					●
	RCMT1606MOMPR	P25C	...-MPR	11855078	●
	RCMT2006MOMPR	P25C		11855080	●



# CUTTING DATA -RPK / -MPR





## General cutting parameters depending on the application

Work piece material	Type of treatment / alloy	Hardness HB	P15C	P25C	P35C	Application	Depth of cut / feed rate	
			$v_c$ [m/min]	$v_c$ [m/min]	$v_c$ [m/min]		Chip groove	$a_p$ [mm]
P	Non-alloyed steel 0-0.45% C	150-250	220-400	170-240	170-190	RPK	3.20 to 7.60	0.60 to 1.00
	Steel							
	Low-alloyed steel	250-300	200-320	100-190	90-150			
	High-alloyed steel	200	180-320	130-210	120-200			
M	Corrosion-resistant steel	200	200-320	130-210	140-180			
	Stainless steel							
	Ferritic	200	220-320	140-210	140-200			
	Austenitic	180	-	100-210	110-190			
K	Duplex	230-260	-	-	80-150			
	Stainless steel							
	Martensitic	330	-	70-100	55-75			
	Cast iron							
K	Grey cast iron	180	140-370	130-210	-			
	Spheroidal	160	190-430	120-240	-			
	Malleable/tempered iron	130	180-520	150-250	-			

		
<b>Consistent cutting depth</b>	<b>Inconsistent cutting depth</b>	<b>Interrupted cut</b>



		X
---	---	---



# AVAILABLE RANGE

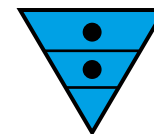

## Medium and roughing turning steel



Insert	Designation	Grade	Chipbreaker	Material number	Available
	CNMG160608RPK	P35C		11854346	●
	CNMG160612RPK	P35C		11854348	●
	CNMG190612RPK	P35C		11854758	●
	CNMG190616RPK	P35C	...-RPK	11861937	●
	SNMG150612RPK	P35C		11855112	●
	SNMG190612RPK	P35C		11855116	●
	RCMT1606MOMPR	P35C		11855079	●
	RCMT2006MOMPR	P35C	...-MPR	11855082	●

# CUTTING DATA - RPK



## General cutting parameters depending on the application

Work piece material	Type of treatment / alloy	Hardness HB	Coated carbide	
			KP20C	$v_c$ [m/min]
P Steel	Non-alloyed steel 0 – 0.45% C	150-250	200-340	
	Low-alloyed steel	250-300	150-290	
	High-alloyed steel	200	150-290	
	Corrosion-resistant steel	200	160-290	
K Cast iron	Grey cast iron	180	150-400	
	Spheroidal	160	200-450	
	Malleable/tempered iron	130	200-550	

Application	Depth of cut / feed rate	
	$a_p$ [mm]	$f$ [mm]
RPK	3.20 to 5.60	0.38 to 0.60
	 Consistent cutting depth	 Inconsistent cutting depth
	 Interrupted cut	
	●	○ X

# AVAILABLE RANGE

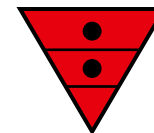

## Turning cast iron neg "K20"

Insert	Designation	Grade	Chipbreaker	Material number	Available
	CNMG160608RPK	KP20C		11781442	●
	CNMG160612RPK	KP20C	...-RPK	11781440	●
	CNMG190612RPK	KP20C		11821832	●

A large, light orange, semi-transparent letter 'Q' is centered on the page. It has a thick stroke and a circular body with a small tail at the bottom right. The word 'MISCELLANEOUS' is written in white, bold, uppercase letters across the middle of the 'Q'.

# MISCELLANEOUS



# CUTTING DATA -MP



## General cutting parameters depending on the application

Work piece material	Type of treatment / alloy	Hardness HB	Coated carbide				Consistent cutting depth	Inconsistent cutting depth	Interrupted cut
			P15C $v_c$ [m/min]	P25C $v_c$ [m/min]	P35C $v_c$ [m/min]	P40C $v_c$ [m/min]			
P	Steel								
	Non-alloyed steel 0-0.45% C	150-250	220-400	170-240	170-200	170-190	●	○	X
	Low-alloyed steel	250-300	200-320	100-190	90-160	90-150			
	High-alloyed steel	200	180-320	130-210	130-170	120-200			
	Corrosion-resistant steel	200	200-320	130-210	130-180	140-180			
M	Stainless steel								
	Ferritic	200	220-320	140-210	140-180	140-200			
	Austenitic	180	-	100-210	100-170	110-190			
	Duplex	230-260	-	-	-	80-150			
	Martensitic	330	-	70-100	-	55-75			
K	Cast iron								
	Grey cast iron	180	140-370	130-210	-	-			
	Spheroidal	160	190-430	120-240	-	-			
	Malleable/tempered iron	130	180-520	150-250	-	-			

# AVAILABLE RANGE

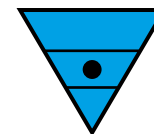

## Turning steel neg medium "P25"

Insert	Designation	Grade	Chipbreaker	Material number	Available
	KNUX160405LMP	P25C	...-MP	11750418	●
	KNUX160405RMP	P25C P25C		11750419	●
	KNUX160410LMP	P25C P25C		12030582	●
	KNUX160410LMP	P25C P25C		12030589	●
	KNUX160405RMP	P35C P35C		11246906	●
	KNUX160405LMP	P35C P35C		11246899	●
	KNUX160405RMP	P40C P40C		11247268	●
	KNUX160405LMP	P40C P40C		11247265	●

A large, light orange, semi-transparent letter 'Q' is centered on the page. The text 'CBN/PCD' is overlaid in white on the 'Q'.

**CBN/PCD**





# CBN – CUBIC BORON NITRIDE

CBN is heat-resistant up to over 1.000° C. Diamond, on the other hand, suffers massive hardness loss at approx. 700° C. which is why it can be ground with CBN when exposed to heat.

With the help of a high-pressure, high-temperature procedure, a dense layer of polycrystalline cubic boron nitride is inseparably deposited on the carbide substrate as a carrier material. Our carbide gives the CBN cutting layer excellent support, even facilitating applications with heavily interrupted cut.

Based on the individual case, various compositions are possible to achieve different mechanical and chemical properties in the cutting material.

## Typical applications of CBN inserts:

- ▲ Iron materials starting from 45 HRC
- ▲ Grey cast iron
- ▲ Spheroidal graphite cast iron
- ▲ Chrome chilled castings
- ▲ Sintered steels
- ▲ Cold and hot working steels
- ▲ Bearing and spring steels
- ▲ Surface-hardened parts

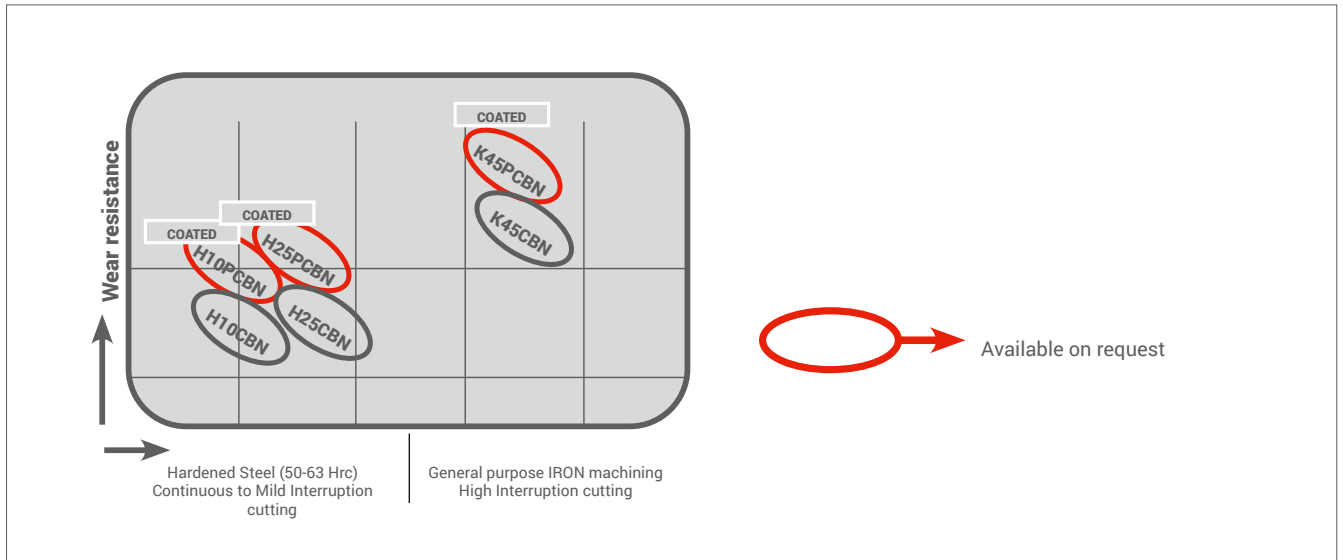

Grade description	Application	Properties
<b>H10CBN</b>	<ul style="list-style-type: none"> <li>▲ For hard turning in slightly interrupted cut and hard finish milling of hardened steel (50-63 Hrc) in continuous cut</li> <li>▲ Very good resistance to cratering</li> <li>▲ Extremely fine structure to achieve surface roughness in the submicron range</li> <li>▲ Cutting speed: (180-300 m/min)</li> <li>▲ Feed rate: (0.07-0.15 mm/rev)</li> </ul>	<p>approx. 45% PCBN Submicron PCBN grain size TiCN binder</p>
<b>H25CBN</b>	<ul style="list-style-type: none"> <li>▲ For turning of all common hardened steels with slightly to strongly interrupted cut</li> <li>▲ Optimal balance between toughness and resistance to cratering and clearance face wear</li> <li>▲ Also suitable for plunging when producing valve seat rings</li> <li>▲ Cutting speed: (150-240 m/min)</li> <li>▲ Feed rate: (0.1-0.2 mm/rev)</li> </ul>	<p>approx. 65% PCBN Grain size 1.5 µm Primarily TiC binder</p>
<b>K45CBN</b>	<ul style="list-style-type: none"> <li>▲ Ideal for applications with long tool life</li> <li>▲ Suitable for the machining of grey cast iron and hard cast iron materials. milling of hardened steel and for the machining of most valve seat ring alloys in strongly interrupted cut</li> <li>▲ First choice for most powder metals containing iron</li> <li>▲ Cutting speed: (50-200 m/min)</li> <li>▲ Feed rate: (0.05-0.2 mm/rev)</li> </ul>	<p>approx. 90% PCBN Grain size 4 µm New binder system</p>

## PCD – POLYCRYSTALLINE DIAMOND

Like monocrystalline diamond, PCD is two to three times harder than carbide and 100 times more abrasion-resistant. As this cutting material, however, is more brittle and more temperature-sensitive (heat resistance up to approx. 650 °C), stable cutting conditions are required.

PCD is a synthesised, extremely tough, interlocked mass of randomly oriented diamond particles in a metal matrix. It is produced by sintering together selected diamond particles at high pressure and temperature. In this way an extremely hard and abrasion-resistant structure is produced.

As a cutting material it is suitable for the manufacture of cutting tools for wood working, plastic and non-ferrous metal machining. PCD cannot be used for steel machining: the carbon from the diamond diffuses into the steel as the temperature rises, so that tool life is strictly limited.

### Typical applications of PCD inserts:

- ▲ Dry and wet machining of aluminium and aluminium alloys
- ▲ Copper, brass, bronze and zinc
- ▲ Magnesium alloys
- ▲ Silver and gold
- ▲ Presintered and sintered carbide
- ▲ Plastics and rubber
- ▲ Titanium alloys
- ▲ Ceramics
- ▲ Glass-fibre reinforced (GFC) and carbon-fibre reinforced (CFC) composites

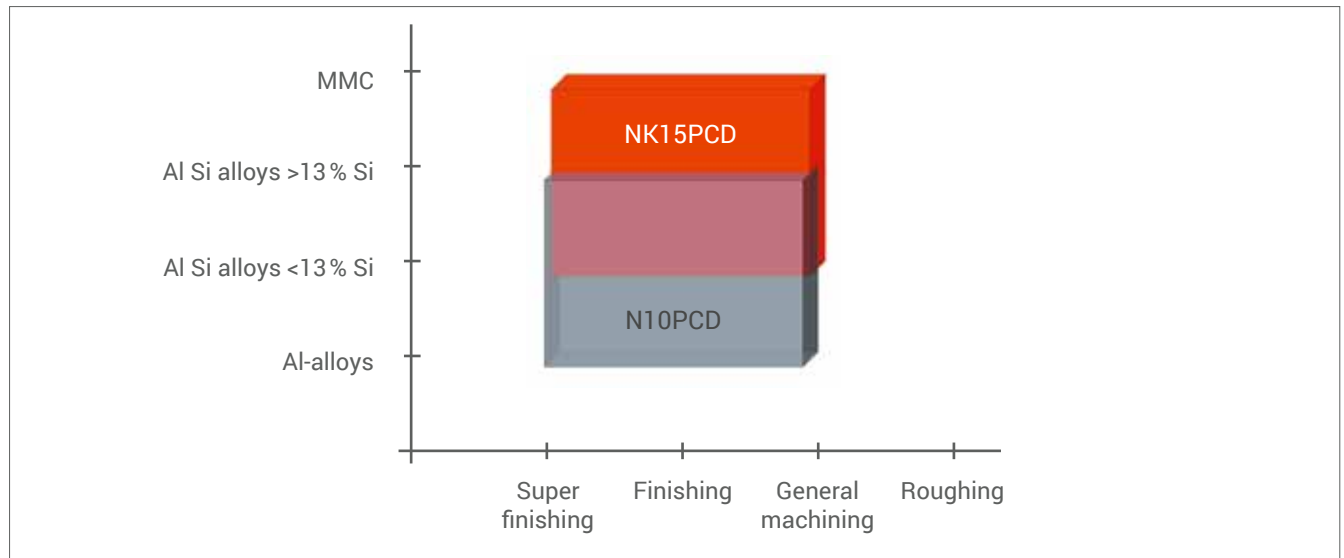

Grade description	Application	Properties
<b>N10PCD</b>	<ul style="list-style-type: none"> <li>▲ Ideal grade for roughing and finishing with only one tool</li> <li>▲ Recommended for alloys with low or medium aluminium content</li> <li>▲ For numerous applications where a balance of toughness and wear resistance is required</li> </ul>	Average grain size: 10 µm.
<b>NK15PCD</b>	<ul style="list-style-type: none"> <li>▲ Suitable for MMCs, aluminium alloys with high silicon content, high-tensile cast iron and the machining of bimetallic materials</li> <li>▲ Excellent abrasion resistance and good heat resistance</li> <li>▲ Very good wear resistance and cutting edge stability</li> </ul>	Grain sizes from 2 – 30 µm.

# CVD THICKFILM DIAMOND

The ultra-hard cutting material CVD has the highest hardness (2.5 x harder than PCD) and the highest wear resistance of all analysed cutting materials.

CVD thickfilm diamond is mainly applied as a cutting material for the machining of aluminium and magnesium alloys and is also preferred for non-ferrous metals. Compared to natural diamond, CVD has the advantage that its characteristics range from reliable to stable, allowing it to achieve a higher repeatability of machining results.

Our CVD inserts are produced by means of chemical vapour deposition. CVD is a pure diamond without a binder phase, making it chemically inert. Due to its high thermal conductivity, CVD is the ideal material for applications with higher operation temperatures.

### Typical applications of CVD inserts:

- ▲ Aluminium and magnesium alloys
- ▲ Particle boards
- ▲ Plastic

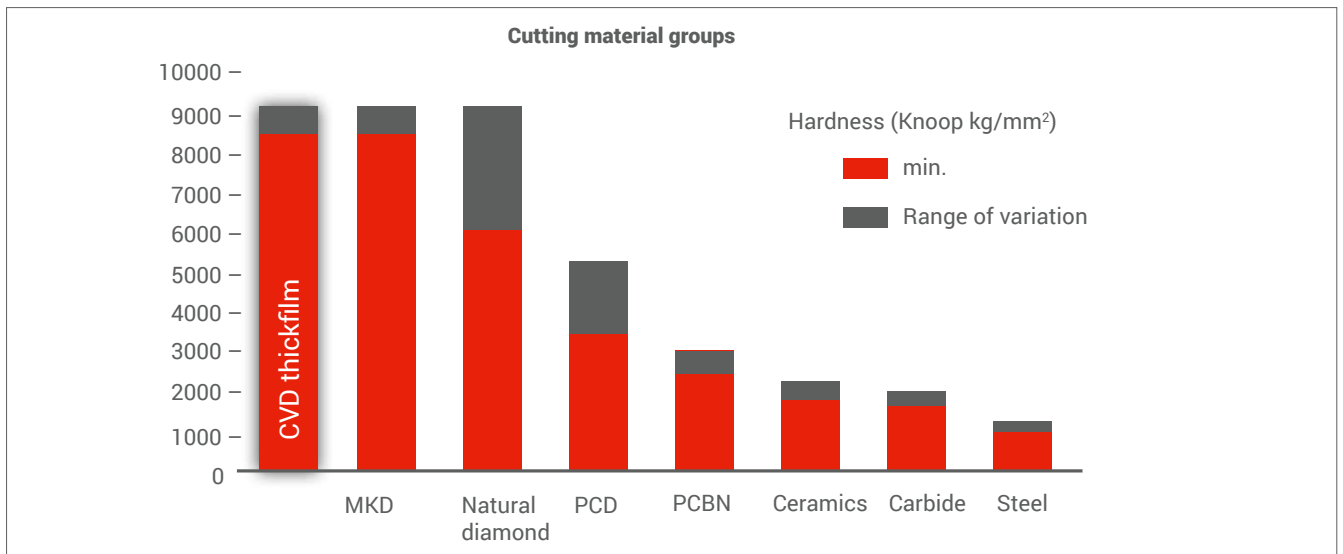

Grade description	Application	Properties
<b>CVD</b>	▲ Suitable for the machining of metal composites, aluminium alloys, glass-fibre reinforced plastics and particle boards	

# HARD TURNING – A FULLY EFFECTIVE ALTERNATIVE TO CYLINDRICAL GRINDING

Hard turning is a machining method used for hardened work pieces with a hardness ranging from 58 to 62 HRC. It has proved to be a fully effective alternative to more costly and time-consuming grinding operations, and offers the following advantages:

## Higher accuracy

Hard turning requires less work piece manipulation. as several operations can be carried out with one set-up and on just one machine. This means greater precision in shaping the work piece. particularly in terms of form accuracy and concentricity.

## Greater flexibility

With one standard tool and one set-up a large variety of products of various forms and sizes can be machined. This ensures greater flexibility in production and reduced changeover times.

## Increased productivity

Compared to grinding, hard turning removes more material in one operation. This makes the hard turning process up to 4 times faster than cylindrical grinding.

## Save costs

With hard turning, you can machine hardened work pieces in one set-up. This reduces the step-by-step machining process carried out on several machines to just one hard turning machine.

## THE DIFFERENCES AT A GLANCE

Comparison	Grinding	Hard turning
Setting time	long	short
Mounting	multiple	single
Cycle times	long	up to 80% shorter
Metal removal rate	low	high
Productivity	low due to several finishing operations	more effective cutting time as finishing is no longer necessary
Investment	high	low
Environmental compatibility	less environment-friendly due to grinding slurry	clean and dry process

# PCBN TURNING

## C geometry

### CCGW

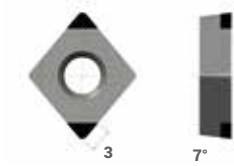

ISO	Edge prep	Uncoated			Coated		
		H10CBN	H25CBN	K45CBN	H10PCBN	H25PCBN	K45PCBN
CCGW060202	S01325MT3	12145031	12145033	12145034	○	○	○
CCGW060204	S01325MT3	12145035	12145036	12145038	○	○	○
CCGW060208	S01325MT3	○	○	○	○	○	○
CCGW09T302	S01325MT3	○	○	○	○	○	○
CCGW09T302	SQ01325MT3	○	○	○	○	○	○
CCGW09T304	S01325MT3	12145039	12145040	12145041	○	○	○
CCGW09T304	SQ01325MT3	○	○	○	○	○	○
CCGW09T308	S01325MT3	12145042	12145043	12145045	○	○	○
CCGW09T308	SQ01325MT3	○	○	○	○	○	○
CCGW120402	S01325MT3	○	○	○	○	○	○
CCGW120404	S01325MT3	12145046	12145048	12145049	○	○	○
CCGW120404	SQ01325MT3	○	○	○	○	○	○
CCGW120408	S01325MT3	○	○	○	○	○	○
CCGW120408	SQ01325MT3	○	○	○	○	○	○
CCGW120412	S01325MT3	○	○	○	○	○	○
CCGW120412	SQ01325MT3	○	○	○	○	○	○

On request ○



# PCBN TURNING

## C geometry

**CNGA**

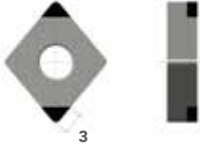

ISO	Edge prep	Uncoated			Coated		
		H10CBN	H25CBN	K45CBN	H10PCBN	H25PCBN	K45PCBN
CNGA120402	S02020MT3	○	○	○	○	○	○
CNGA120402	SQ02020MT3	○	○	○	○	○	○
CNGA120404	S01325MT3	12145050	12145051	○	○	○	○
CNGA120404	S02020MT3	○	○	12145052	○	○	○
CNGA120404	SQ02020MT3	○	○	○	○	○	○
CNGA120408	S01325MT3	12145053	12145055	○	○	○	○
CNGA120408	S02020MT3	○	○	12145056	○	○	○
CNGA120408	SQ02020MT3	○	○	○	○	○	○
CNGA120412	S01325MT3	12145061	12145062	○	○	○	○
CNGA120412	S02020MT3	○	○	12145064	○	○	○
CNGA120412	SQ02020MT3	○	○	○	○	○	○

**CNGA**

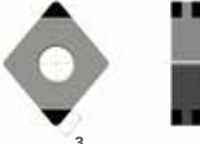

ISO	Edge prep	Uncoated			Coated		
		H10CBN	H25CBN	K45CBN	H10PCBN	H25PCBN	K45PCBN
CNGA120402	S02020DMT3	○	○	○	○	○	○
CNGA120402	SQ02020DMT3	○	○	○	○	○	○
CNGA120404	S02020DMT3	○	○	○	○	○	○
CNGA120404	SQ02020DMT3	○	○	○	○	○	○
CNGA120408	S02020DMT3	○	○	○	○	○	○
CNGA120408	SQ02020DMT3	○	○	○	○	○	○
CNGA120412	S02020DMT3	○	○	○	○	○	○
CNGA120412	SQ02020DMT3	○	○	○	○	○	○

On request ○

# PCBN TURNING

## D geometry

DCGW

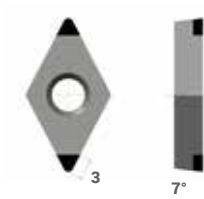

ISO	Edge prep	Uncoated			Coated		
		H10CBN	H25CBN	K45CBN	H10PCBN	H25PCBN	K45PCBN
DCGW070202	S01325MT3	H	H	K	H	H	K
DCGW070204	S01325MT3	12145065	12145069	12145070	○	○	○
DCGW070204	SQ01325MT3	12145072	12145074	12145075	○	○	○
DCGW070208	S01325MT3	○	○	○	○	○	○
DCGW070208	SQ01325MT3	○	○	○	○	○	○
DCGW11T302	S01325MT3	○	○	○	○	○	○
DCGW11T304	S01325MT3	12145077	12145079	12145081	○	○	○
DCGW11T304	SQ01325MT3	12145083	12145084	12145085	○	○	○
DCGW11T308	S01325MT3	○	○	○	○	○	○
DCGW11T308	SQ01325MT3	○	○	○	○	○	○

On request ○

# PCBN TURNING

## D geometry

### DNGA

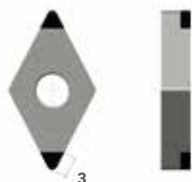

ISO	Edge prep	Uncoated			Coated		
		H10CBN	H25CBN	K45CBN	H10PCBN	H25PCBN	K45PCBN
DNGA110402	S02020MT3	○	○	<b>K</b>	○	○	○
DNGA110404	S02020MT3	○	○	○	○	○	○
DNGA110408	S02020MT3	○	○	○	○	○	○
DNGA150402	S02020MT3	○	○	○	○	○	○
DNGA150404	S02020MT3	○	○	○	○	○	○
DNGA150404	SQ02020MT3	○	○	○	○	○	○
DNGA150408	S02020MT3	○	○	○	○	○	○
DNGA150408	SQ02020MT3	○	○	○	○	○	○
DNGA150412	S02020MT3	○	○	○	○	○	○
DNGA150602	S02020MT3	○	○	○	○	○	○
DNGA150604	S01325MT3	12145087	12145089	○	○	○	○
DNGA150604	S02020MT3	○	○	12145090	○	○	○
DNGA150604	SQ02020MT3	○	○	○	○	○	○
DNGA150608	S01325MT3	12145092	12145094	○	○	○	○
DNGA150608	S02020MT3	○	○	12145096	○	○	○
DNGA150608	SQ02020MT3	○	○	○	○	○	○
DNGA150612	S01325MT3	12145098	12145100	○	○	○	○
DNGA150612	S02020MT3	○	○	12145101	○	○	○

### DNGA

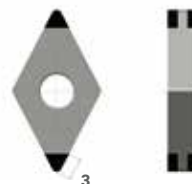

ISO	Edge prep	Uncoated			Coated		
		H10CBN	H25CBN	K45CBN	H10PCBN	H25PCBN	K45PCBN
DNGA110402	S02020DMT3	○	○	○	○	○	○
DNGA110404	S02020DMT3	○	○	○	○	○	○
DNGA110408	S02020DMT3	○	○	○	○	○	○
DNGA150402	S02020DMT3	○	○	○	○	○	○
DNGA150404	S02020DMT3	○	○	○	○	○	○
DNGA150404	SQ02020DMT3	○	○	○	○	○	○
DNGA150408	S02020DMT3	○	○	○	○	○	○
DNGA150408	SQ02020DMT3	○	○	○	○	○	○
DNGA150412	S02020DMT3	○	○	○	○	○	○
DNGA150602	S02020DMT3	○	○	○	○	○	○
DNGA150604	S02020DMT3	○	○	○	○	○	○
DNGA150604	SQ02020DMT3	○	○	○	○	○	○
DNGA150608	S02020DMT3	○	○	○	○	○	○
DNGA150608	SQ02020DMT3	○	○	○	○	○	○
DNGA150612	S02020DMT3	○	○	○	○	○	○

On request ○

# PCBN TURNING

## S geometry

### SCGW

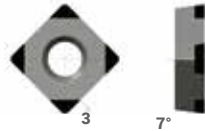

ISO	Edge prep	Uncoated			Coated		
		H10CBN	H25CBN	K45CBN	H10PCBN	H25PCBN	K45PCBN
SCGW09T302	S01325MT3	○	○	○	○	○	○
SCGW09T304	S01325MT3	○	○	○	○	○	○
SCGW09T308	S01325MT3	○	○	○	○	○	○
SCGW120402	S01325MT3	○	○	○	○	○	○
SCGW120404	S01325MT3	○	○	○	○	○	○
SCGW120408	S01325MT3	○	○	○	○	○	○
SCGW120412	S01325MT3	○	○	○	○	○	○

### SNGA

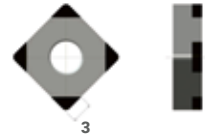

ISO	Edge prep	Uncoated			Coated		
		H10CBN	H25CBN	K45CBN	H10PCBN	H25PCBN	K45PCBN
SNGA120404	S01325MT3	○	○	○	○	○	○
SNGA120404	S02020MT3	○	○	○	○	○	○
SNGA120408	S01325MT3	○	○	○	○	○	○
SNGA120408	S02020MT3	○	○	○	○	○	○
SNGA120412	S02020MT3	○	○	○	○	○	○

### SNGA

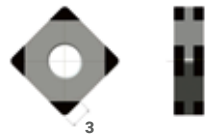

ISO	Edge prep	Uncoated			Coated		
		H10CBN	H25CBN	K45CBN	H10PCBN	H25PCBN	K45PCBN
SNGA120404	S01325DMT3	○	○	○	○	○	○
SNGA120404	S02020DMT3	○	○	○	○	○	○
SNGA120408	S01325DMT3	○	○	○	○	○	○
SNGA120408	S02020DMT3	○	○	○	○	○	○
SNGA120412	S02020DMT3	○	○	○	○	○	○

On request ○

# PCBN TURNING

## T geometry

**TCGW**



ISO	Edge prep	Uncoated			Coated		
		H10CBN	H25CBN	K45CBN	H10PCBN	H25PCBN	K45PCBN
TCGW090202	S01325MT3	○	○	○	○	○	○
TCGW090204	S01325MT3	○	○	○	○	○	○
TCGW090208	S01325MT3	○	○	○	○	○	○
TCGW110202	S01325MT3	○	○	○	○	○	○
TCGW110204	S01325MT3	12145104	12145106	12145108	○	○	○
TCGW110208	S01325MT3	12145110	12145113	12145116	○	○	○
TCGW16T302	S01325MT3	○	○	○	○	○	○
TCGW16T304	S01325MT3	12145119	12145121	12145124	○	○	○
TCGW16T308	S01325MT3	12145147	12145148	12145149	○	○	○

**TNGA**



ISO	Edge prep	Uncoated			Coated		
		H10CBN	H25CBN	K45CBN	H10PCBN	H25PCBN	K45PCBN
TNGA160402	S02020MT3	○	○	○	○	○	○
TNGA160404	S01325MT3	12145150	12145151	○	○	○	○
TNGA160404	S02020MT3	○	○	12145153	○	○	○
TNGA160408	S01325MT3	12145154	12145155	○	○	○	○
TNGA160408	S02020MT3	○	○	12145156	○	○	○
TNGA160412	S01325MT3	12145157	12145158	○	○	○	○
TNGA160412	S02020MT3	○	○	12145159	○	○	○

**TNGA**



ISO	Edge prep	Uncoated			Coated		
		H10CBN	H25CBN	K45CBN	H10PCBN	H25L	K45PCBN
TNGA160402	S02020DMT3	○	○	○	○	○	○
TNGA160404	S01325DMT3	○	○	○	○	○	○
TNGA160404	S02020DMT3	○	○	○	○	○	○
TNGA160408	S01325DMT3	○	○	○	○	○	○
TNGA160408	S02020DMT3	○	○	○	○	○	○
TNGA160412	S01325DMT3	○	○	○	○	○	○
TNGA160412	S02020DMT3	○	○	○	○	○	○

On request ○

# PCBN TURNING

## V geometry

### VCGW



ISO	Edge prep	Uncoated			Coated		
		H10CBN	H25CBN	K45CBN	H10PCBN	H25PCBN	K45PCBN
VCGW 070202	S01325MT3	○	○	○	○	○	○
VCGW 070204	S01325MT3	○	○	○	○	○	○
VCGW110302	S01325MT3	○	○	○	○	○	○
VCGW110304	S01325MT3	12145160	12145162	○	○	○	○
VCGW110304	S02020MT3	○	○	12145163	○	○	○
VCGW110308	S01325MT3	○	○	○	○	○	○
VCGW160402	S01325MT3	○	○	○	○	○	○
VCGW160404	S01325MT3	12145165	12145167	○	○	○	○
VCGW160404	S02020MT3	○	○	12145168	○	○	○
VCGW160408	S01325MT3	12145169	12145172	○	○	○	○
VCGW160408	S02020MT3	○	○	12145174	○	○	○
VCGW160412	S01325MT3	○	○	○	○	○	○

### VNGA



ISO	Edge prep	Uncoated			Coated		
		H10CBN	H25CBN	K45CBN	H10PCBN	H25PCBN	K45PCBN
VNGA160402	S02020MT3	○	○	○	○	○	○
VNGA160404	S01325MT3	○	○	○	○	○	○
VNGA160404	S02020MT3	○	○	○	○	○	○
VNGA160408	S01325MT3	○	○	○	○	○	○
VNGA160408	S02020MT3	○	○	○	○	○	○
VNGA160412	S01325MT3	○	○	○	○	○	○
VNGA160412	S02020MT3	○	○	○	○	○	○

### VNGA



ISO	Edge prep	Uncoated			Coated		
		H10CBN	H25CBN	K45CBN	H10PCBN	H25PCBN	K45PCBN
VNGA160402	S02020DMT3	○	○	○	○	○	○
VNGA160404	S01325MT3	○	○	○	○	○	○
VNGA160404	S02020DMT3	○	○	○	○	○	○
VNGA160408	S01325MT3	○	○	○	○	○	○
VNGA160408	S02020DMT3	○	○	○	○	○	○
VNGA160412	S01325MT3	○	○	○	○	○	○
VNGA160412	S02020DMT3	○	○	○	○	○	○

On request ○

# PCBN TURNING

## W geometry

### WNGA



ISO	Edge prep	Uncoated			Coated		
		H10CBN	H25CBN	K45CBN	H10PCBN	H25PCBN	K45PCBN
WNGA080402	S02020MT3	○	○	○	○	○	○
WNGA080404	S01325MT3	○	○	○	○	○	○
WNGA080404	S02020MT3	○	○	○	○	○	○
WNGA080404	SQ02020MT3	○	○	○	○	○	○
WNGA080408	S01325MT3	○	○	○	○	○	○
WNGA080408	S02020MT3	○	○	○	○	○	○
WNGA080408	SQ02020MT3	○	○	○	○	○	○
WNGA080412	S01325MT3	○	○	○	○	○	○
WNGA080412	S02020MT3	○	○	○	○	○	○

### WNGA



ISO	Edge prep	Uncoated			Coated		
		H10CBN	H25CBN	K45CBN	H10PCBN	H25PCBN	K45PCBN
WNGA080402	S02020DMT3	○	○	○	○	○	○
WNGA080404	S01325DMT3	○	○	○	○	○	○
WNGA080404	S02020DMT3	○	○	○	○	○	○
WNGA080404	SQ02020DMT3	○	○	○	○	○	○
WNGA080408	S01325DMT3	○	○	○	○	○	○
WNGA080408	S02020DMT3	○	○	○	○	○	○
WNGA080408	SQ02020DMT3	○	○	○	○	○	○
WNGA080412	S01325DMT3	○	○	○	○	○	○
WNGA080412	S02020DMT3	○	○	○	○	○	○

On request ○

# PCD TURNING

## C geometry

### CCGW

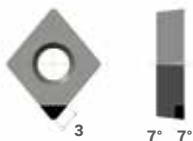

ISO	Edge prep	Uncoated	
		N10PCD	NK15PCD
CCGW060202	FST3	N	N
CCGW060204	FST3	12145501	12145502
CCGW060208	FST3	○	○
CCGW09T302	FST3	○	○
CCGW09T304	FST3	12145505	12145506
CCGW09T308	FST3	12145507	12145509
CCGW09T312	FST3	○	○
CCGW120402	FST3	○	○
CCGW120404	FST3	○	○
CCGW120408	FST3	12145510	12145511
CCGW120412	FST3	○	○

### CPGW

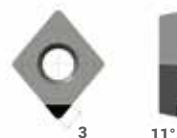

ISO	Edge prep	Uncoated	
		N10PCD	NK15PCD
CPGW060202	FST3	○	○
CPGW060204	FST3	○	○
CPGW060208	FST3	○	○
CPGW09T302	FST3	○	○
CPGW09T304	FST3	○	○
CPGW09T308	FST3	○	○
CPGW120404	FST3	○	○
CPGW120408	FST3	○	○
CPGW120412	FST3	○	○

### CCGT

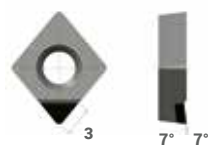

ISO	Edge prep	Uncoated	
		N10PCD	NK15PCD
CCGT060202	FST3	12145512	12145513
CCGT060204	FST3	12145514	12145515
CCGT060208	FST3	○	○
CCGT09T302	FST3	○	○
CCGT09T304	FST3	12145516	12145517
CCGT09T308	FST3	12145518	12145519
CCGT09T312	FST3	○	○
CCGT120402	FST3	○	○
CCGT120404	FST3	○	○
CCGT120408	FST3	12145520	12145521

### CPGT

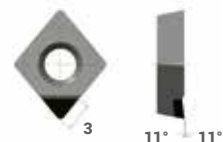

ISO	Edge prep	Uncoated	
		N10PCD	NK15PCD
CPGT060202	FST3	○	○
CPGT060204	FST3	○	○
CPGT060208	FST3	○	○



# PCD TURNING

## C geometry

### CCGW

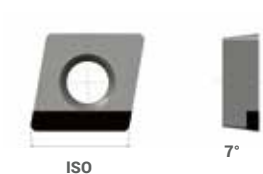

ISO	Edge prep	Uncoated	
		N10PCD	NK15PCD
CCGW060202	FRST6	<input checked="" type="checkbox"/>	<input type="checkbox"/>
CCGW060204	FRST6	<input type="checkbox"/>	<input type="checkbox"/>
CCGW060208	FRST6	<input type="checkbox"/>	<input type="checkbox"/>
CCGW09T304	FRST9	<input type="checkbox"/>	<input type="checkbox"/>
CCGW09T308	FRST9	<input type="checkbox"/>	<input type="checkbox"/>
CCGW09T312	FRST9	<input type="checkbox"/>	<input type="checkbox"/>
CCGW120402	FRST12	<input type="checkbox"/>	<input type="checkbox"/>
CCGW120404	FRST12	<input type="checkbox"/>	<input type="checkbox"/>
CCGW120408	FRST12	<input type="checkbox"/>	<input type="checkbox"/>

### CCGW



ISO	Edge prep	Uncoated	
		N10PCD	NK15PCD
CCGW060202	FLST6	<input type="checkbox"/>	<input type="checkbox"/>
CCGW060204	FLST6	<input type="checkbox"/>	<input type="checkbox"/>
CCGW060208	FLST6	<input type="checkbox"/>	<input type="checkbox"/>
CCGW09T304	FLST9	<input type="checkbox"/>	<input type="checkbox"/>
CCGW09T308	FLST9	<input type="checkbox"/>	<input type="checkbox"/>
CCGW09T312	FLST9	<input type="checkbox"/>	<input type="checkbox"/>
CCGW120402	FLST12	<input type="checkbox"/>	<input type="checkbox"/>
CCGW120404	FLST12	<input type="checkbox"/>	<input type="checkbox"/>
CCGW120408	FLST12	<input type="checkbox"/>	<input type="checkbox"/>

### CCGT

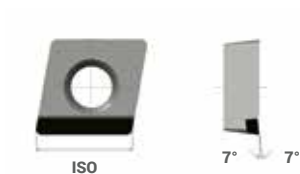

ISO	Edge prep	Uncoated	
		N10PCD	NK15PCD
CCGT060202	FRST6	<input type="checkbox"/>	<input type="checkbox"/>
CCGT060204	FRST6	<input type="checkbox"/>	<input type="checkbox"/>
CCGT060208	FRST6	<input type="checkbox"/>	<input type="checkbox"/>
CCGT09T304	FRST9	<input type="checkbox"/>	<input type="checkbox"/>
CCGT09T308	FRST9	<input type="checkbox"/>	<input type="checkbox"/>
CCGT09T312	FRST9	<input type="checkbox"/>	<input type="checkbox"/>
CCGT120402	FRST12	<input type="checkbox"/>	<input type="checkbox"/>
CCGT120404	FRST12	<input type="checkbox"/>	<input type="checkbox"/>
CCGT120408	FRST12	<input type="checkbox"/>	<input type="checkbox"/>

### CCGT

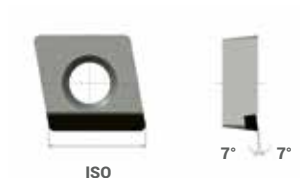

ISO	Edge prep	Uncoated	
		N10PCD	NK15PCD
CCGT060202	FLST6	<input type="checkbox"/>	<input type="checkbox"/>
CCGT060204	FLST6	<input type="checkbox"/>	<input type="checkbox"/>
CCGT060208	FLST6	<input type="checkbox"/>	<input type="checkbox"/>
CCGT09T304	FLST6	<input type="checkbox"/>	<input type="checkbox"/>
CCGT09T308	FLST9	<input type="checkbox"/>	<input type="checkbox"/>
CCGT09T312	FLST9	<input type="checkbox"/>	<input type="checkbox"/>
CCGT120402	FLST12	<input type="checkbox"/>	<input type="checkbox"/>
CCGT120404	FLST12	<input type="checkbox"/>	<input type="checkbox"/>
CCGT120408	FLST12	<input type="checkbox"/>	<input type="checkbox"/>

# PCD TURNING

## D geometry

### DCGW

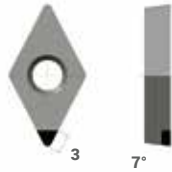

ISO	Edge prep	Uncoated	
		N10PCD	NK15PCD
DCGW070201	FST3	N	N
DCGW070202	FST3	○	○
DCGW070204	FST3	12145522	12145525
DCGW070208	FST3	12145526	12145529
DCGW11T301	FST3	○	○
DCGW11T302	FST3	○	○
DCGW11T304	FST3	12145540	12145542
DCGW11T308	FST3	12145543	12145545
DCGW11T312	FST3	12145546	12145547
		○	○

### DCGT

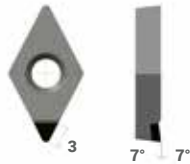

ISO	Edge prep	Uncoated	
		N10PCD	NK15PCD
DCGT070201	FST3	N	N
DCGT070202	FST3	○	○
DCGT070204	FST3	12145551	12145552
DCGT070208	FST3	12145553	12145555
DCGT11T301	FST3	○	○
DCGT11T302	FST3	○	○
DCGT11T304	FST3	12145557	12145558
DCGT11T308	FST3	12145559	12145561
DCGT11T312	FST3	12145564	12145565
		○	○

On request ○

# PCD TURNING

## S geometry

### SCGW

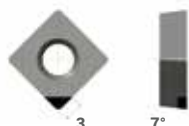

ISO	Edge prep	Uncoated	
		N10PCD	NK15PCD
SCGW09T302	FST3	<input checked="" type="checkbox"/>	<input checked="" type="checkbox"/>
SCGW09T304	FST3	<input type="checkbox"/>	<input type="checkbox"/>
SCGW09T308	FST3	<input type="checkbox"/>	<input type="checkbox"/>
SCGW09T312	FST3	<input type="checkbox"/>	<input type="checkbox"/>
SCGW120404	FST3	<input type="checkbox"/>	<input type="checkbox"/>
SCGW120408	FST3	<input type="checkbox"/>	<input type="checkbox"/>
SCGW120412	FST3	<input type="checkbox"/>	<input type="checkbox"/>

### SCGW



ISO	Edge prep	Uncoated	
		N10PCD	NK15PCD
SCGW09T304	FST9	<input type="checkbox"/>	<input type="checkbox"/>
SCGW09T308	FST9	<input type="checkbox"/>	<input type="checkbox"/>
SCGW09T312	FST9	<input type="checkbox"/>	<input type="checkbox"/>
SCGW120404	FST12	<input type="checkbox"/>	<input type="checkbox"/>
SCGW120408	FST12	<input type="checkbox"/>	<input type="checkbox"/>
SCGW120412	FST12	<input type="checkbox"/>	<input type="checkbox"/>

### SCGT

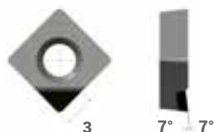

ISO	Edge prep	Uncoated	
		N10PCD	NK15PCD
SCGT09T302	FST3	<input type="checkbox"/>	<input type="checkbox"/>
SCGT09T304	FST3	12145566	12145567
SCGT09T308	FST3	12145568	12145569
SCGT09T312	FST3	<input type="checkbox"/>	<input type="checkbox"/>
SCGT120404	FST3	<input type="checkbox"/>	<input type="checkbox"/>
SCGT120408	FST3	<input type="checkbox"/>	<input type="checkbox"/>
SCGT120412	FST3	<input type="checkbox"/>	<input type="checkbox"/>

### SCGT

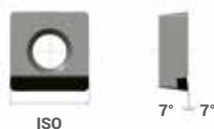

ISO	Edge prep	Uncoated	
		N10PCD	NK15PCD
SCGT09T304	FST9	<input type="checkbox"/>	<input type="checkbox"/>
SCGT09T308	FST9	<input type="checkbox"/>	<input type="checkbox"/>
SCGT09T312	FST9	<input type="checkbox"/>	<input type="checkbox"/>
SCGT120404	FST12	<input type="checkbox"/>	<input type="checkbox"/>
SCGT120408	FST12	<input type="checkbox"/>	<input type="checkbox"/>
SCGT120412	FST12	<input type="checkbox"/>	<input type="checkbox"/>

On request

# PCD TURNING

## T geometry

### TCGW

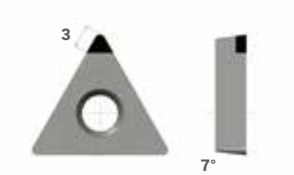

ISO	Edge prep	Uncoated	
		N10PCD	NK15PCD
TCGW090202	FST3	<input checked="" type="radio"/>	<input type="radio"/>
TCGW090204	FST3	<input type="radio"/>	<input type="radio"/>
TCGW090208	FST3	<input type="radio"/>	<input type="radio"/>
TCGW110202	FST3	<input type="radio"/>	<input type="radio"/>
TCGW110204	FST3	<input type="radio"/>	<input type="radio"/>
TCGW110208	FST3	<input type="radio"/>	<input type="radio"/>
TCGW16T302	FST3	<input type="radio"/>	<input type="radio"/>
TCGW16T304	FST3	<input type="radio"/>	<input type="radio"/>
TCGW16T308	FST3	<input type="radio"/>	<input type="radio"/>
TCGW16T312	FST3	<input type="radio"/>	<input type="radio"/>

### TCGW

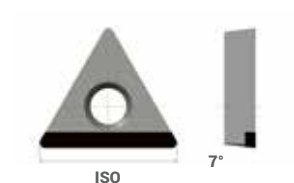

ISO	Edge prep	Uncoated	
		N10PCD	NK15PCD
TCGW090202	FST9	<input type="radio"/>	<input type="radio"/>
TCGW090204	FST9	<input type="radio"/>	<input type="radio"/>
TCGW090208	FST9	<input type="radio"/>	<input type="radio"/>
TCGW110202	FST11	<input type="radio"/>	<input type="radio"/>
TCGW110204	FST11	<input type="radio"/>	<input type="radio"/>
TCGW110208	FST11	<input type="radio"/>	<input type="radio"/>
TCGW16T302	FST16	<input type="radio"/>	<input type="radio"/>
TCGW16T304	FST16	<input type="radio"/>	<input type="radio"/>
TCGW16T308	FST16	<input type="radio"/>	<input type="radio"/>
TCGW16T312	FST16	<input type="radio"/>	<input type="radio"/>

On request

# PCD TURNING

## T geometry

### TCGT

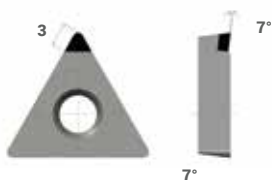

ISO	Edge prep	Uncoated	
		N10PCD	NK15PCD
TCGT090202	FST3	<input type="radio"/>	<input type="radio"/>
TCGT090204	FST3	<input type="radio"/>	<input type="radio"/>
TCGT090208	FST3	<input type="radio"/>	<input type="radio"/>
TCGT110202	FST3	12145799	12145800
TCGT110204	FST3	12145801	12145802
TCGT110208	FST3	<input type="radio"/>	<input type="radio"/>
TCGT16T302	FST3	<input type="radio"/>	<input type="radio"/>
TCGT16T304	FST3	12145804	12145805
TCGT16T308	FST3	12145806	12145807
TCGT16T312	FST3	<input type="radio"/>	<input type="radio"/>

### TCGT

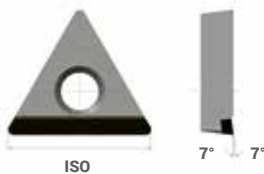

ISO	Edge prep	Uncoated	
		N10PCD	NK15PCD
TCGT090202	FST9	<input type="radio"/>	<input type="radio"/>
TCGT090204	FST9	<input type="radio"/>	<input type="radio"/>
TCGT090208	FST9	<input type="radio"/>	<input type="radio"/>
TCGT110202	FST11	<input type="radio"/>	<input type="radio"/>
TCGT110204	FST11	<input type="radio"/>	<input type="radio"/>
TCGT110208	FST11	<input type="radio"/>	<input type="radio"/>
TCGT16T302	FST16	<input type="radio"/>	<input type="radio"/>
TCGT16T304	FST16	<input type="radio"/>	<input type="radio"/>
TCGT16T308	FST16	<input type="radio"/>	<input type="radio"/>
TCGT16T312	FST16	<input type="radio"/>	<input type="radio"/>

On request

# PCD TURNING

## V geometry

### VCGW



ISO	Edge prep	Uncoated	
		N10PCD	NK15PCD
VCGW070201	FST3	<input checked="" type="radio"/>	<input type="radio"/>
VCGW070202	FST3	<input type="radio"/>	<input type="radio"/>
VCGW070204	FST3	<input type="radio"/>	<input type="radio"/>
VCGW070208	FST3	<input type="radio"/>	<input type="radio"/>
VCGW110301	FST3	<input type="radio"/>	<input type="radio"/>
VCGW110302	FST3	12145809	12145810
VCGW110304	FST3	12145811	12145812
VCGW110308	FST3	<input type="radio"/>	<input type="radio"/>
VCGW160401	FST3	<input type="radio"/>	<input type="radio"/>
VCGW160402	FST3	<input type="radio"/>	<input type="radio"/>
VCGW160404	FST3	12145813	12145814
VCGW160408	FST3	<input type="radio"/>	<input type="radio"/>
VCGW160412	FST3	<input type="radio"/>	<input type="radio"/>

### VCGT



ISO	Edge prep	Uncoated	
		N10PCD	NK15PCD
VCGT070201	FST3	<input type="radio"/>	<input type="radio"/>
VCGT070202	FST3	<input type="radio"/>	<input type="radio"/>
VCGT070204	FST3	<input type="radio"/>	<input type="radio"/>
VCGT070208	FST3	<input type="radio"/>	<input type="radio"/>
VCGT110301	FST3	<input type="radio"/>	<input type="radio"/>
VCGT110302	FST3	12145815	12145816
VCGT110304	FST3	12145817	12145818
VCGT110308	FST3	<input type="radio"/>	<input type="radio"/>
VCGT160401	FST3	<input type="radio"/>	<input type="radio"/>
VCGT160402	FST3	12145819	12145820
VCGT160404	FST3	12145821	12145822
VCGT160408	FST3	12145824	12145825
VCGT160412	FST3	<input type="radio"/>	<input type="radio"/>

On request

# CVD TURNING

## C geometry

### CCGW

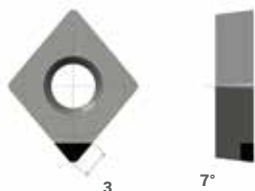

ISO	Edge prep	Uncoated
		CVD
CCGW060202	FST3	<input checked="" type="radio"/>
CCGW060204	FST3	<input type="radio"/>
CCGW060208	FST3	<input type="radio"/>
CCGW09T302	FST3	<input type="radio"/>
CCGW09T304	FST3	<input type="radio"/>
CCGW09T308	FST3	<input type="radio"/>
CCGW09T312	FST3	<input type="radio"/>
CCGW120402	FST3	<input type="radio"/>
CCGW120404	FST3	<input type="radio"/>
CCGW120408	FST3	<input type="radio"/>
CCGW120412	FST3	<input type="radio"/>

### CCGW

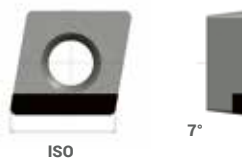

ISO	Edge prep	Uncoated
		CVD
CCGW060202	FRST6	<input checked="" type="radio"/>
CCGW060204	FRST6	<input type="radio"/>
CCGW060208	FRST6	<input type="radio"/>
CCGW09T304	FRST9	<input type="radio"/>
CCGW09T308	FRST9	<input type="radio"/>
CCGW09T312	FRST9	<input type="radio"/>
CCGW120402	FRST12	<input type="radio"/>
CCGW120404	FRST12	<input type="radio"/>
CCGW120408	FRST12	<input type="radio"/>

### CCGW

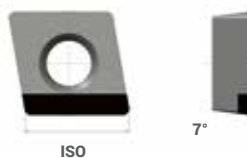

ISO	Edge prep	Uncoated
		CVD
CCGW060202	FLST6	<input checked="" type="radio"/>
CCGW060204	FLST6	<input type="radio"/>
CCGW060208	FLST6	<input type="radio"/>
CCGW09T304	FLST9	<input type="radio"/>
CCGW09T308	FLST9	<input type="radio"/>
CCGW09T312	FLST9	<input type="radio"/>
CCGW120402	FLST12	<input type="radio"/>
CCGW120404	FLST12	<input type="radio"/>
CCGW120408	FLST12	<input type="radio"/>

On request

# CVD TURNING

## C geometry

### CCGT

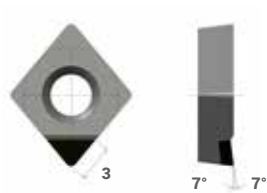

ISO	Edge prep	Uncoated
		CVD
CCGT060202	FST3	<b>N</b>
CCGT060204	FST3	<input type="radio"/>
CCGT060208	FST3	<input type="radio"/>
CCGT09T302	FST3	<input type="radio"/>
CCGT09T304	FST3	<input type="radio"/>
CCGT09T308	FST3	<input type="radio"/>
CCGT09T312	FST3	<input type="radio"/>
CCGT120402	FST3	<input type="radio"/>
CCGT120404	FST3	<input type="radio"/>
CCGT120408	FST3	<input type="radio"/>

### CCGT

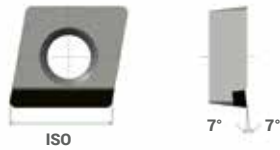

ISO	Edge prep	Uncoated
		CVD
CCGT060202	FRST6	<b>N</b>
CCGT060204	FRST6	<input type="radio"/>
CCGT060208	FRST6	<input type="radio"/>
CCGT09T304	FRST9	<input type="radio"/>
CCGT09T308	FRST9	<input type="radio"/>
CCGT09T312	FRST9	<input type="radio"/>
CCGT120402	FRST12	<input type="radio"/>
CCGT120404	FRST12	<input type="radio"/>
CCGT120408	FRST12	<input type="radio"/>

### CCGT

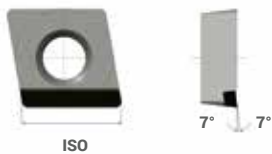

ISO	Edge prep	Uncoated
		CVD
CCGT060202	FLST6	<b>N</b>
CCGT060204	FLST6	<input type="radio"/>
CCGT060208	FLST6	<input type="radio"/>
CCGT09T304	FLST9	<input type="radio"/>
CCGT09T308	FLST9	<input type="radio"/>
CCGT09T312	FLST9	<input type="radio"/>
CCGT120402	FLST12	<input type="radio"/>
CCGT120404	FLST12	<input type="radio"/>
CCGT120408	FLST12	<input type="radio"/>

On request



# CVD TURNING

## C geometry

### CPGW

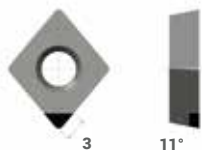

ISO	Edge prep	Uncoated CVD
CPGW060202	FST3	<input checked="" type="radio"/>
CPGW060204	FST3	<input type="radio"/>
CPGW060208	FST3	<input type="radio"/>
CPGW09T302	FST3	<input type="radio"/>
CPGW09T304	FST3	<input type="radio"/>
CPGW09T308	FST3	<input type="radio"/>
CPGW120404	FST3	<input type="radio"/>
CPGW120408	FST3	<input type="radio"/>
CPGW120412	FST3	<input type="radio"/>

### CPGT

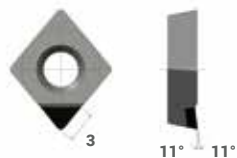

ISO	Edge prep	Uncoated CVD
CPGT060202	FST3	<input type="radio"/>
CPGT060204	FST3	<input type="radio"/>
CPGT060208	FST3	<input type="radio"/>

On request

# CVD TURNING

## D geometry

### DCGW

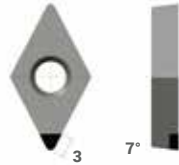

ISO	Edge prep	Uncoated
		CVD
DCGW070201	FST3	<b>N</b>
DCGW070202	FST3	○
DCGW070204	FST3	○
DCGW070208	FST3	○
DCGW11T301	FST3	○
DCGW11T302	FST3	○
DCGW11T304	FST3	○
DCGW11T308	FST3	○
DCGW11T312	FST3	○

### DCGT

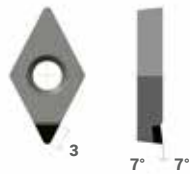

ISO	Edge prep	Uncoated
		CVD
DCGT070201	FST3	<b>N</b>
DCGT070202	FST3	○
DCGT070204	FST3	○
DCGT070208	FST3	○
DCGT11T301	FST3	○
DCGT11T302	FST3	○
DCGT11T304	FST3	○
DCGT11T308	FST3	○
DCGT11T312	FST3	○

On request ○

# CVD TURNING

## S geometry

### SCGW



ISO	Edge prep	Uncoated CVD
SCGW09T302	FST3	<input checked="" type="radio"/>
SCGW09T304	FST3	<input type="radio"/>
SCGW09T308	FST3	<input type="radio"/>
SCGW09T312	FST3	<input type="radio"/>
SCGW120404	FST3	<input type="radio"/>
SCGW120408	FST3	<input type="radio"/>
SCGW120412	FST3	<input type="radio"/>

### SCGW



ISO	Edge prep	Uncoated CVD
SCGW09T304	FST9	<input checked="" type="radio"/>
SCGW09T308	FST9	<input type="radio"/>
SCGW09T312	FST9	<input type="radio"/>
SCGW120404	FST12	<input type="radio"/>
SCGW120408	FST12	<input type="radio"/>
SCGW120412	FST12	<input type="radio"/>

### SCGT

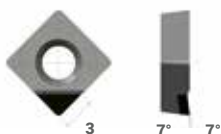

ISO	Edge prep	Uncoated CVD
SCGT09T302	FST3	<input checked="" type="radio"/>
SCGT09T304	FST3	<input type="radio"/>
SCGT09T308	FST3	<input type="radio"/>
SCGT09T312	FST3	<input type="radio"/>
SCGT120404	FST3	<input type="radio"/>
SCGT120408	FST3	<input type="radio"/>
SCGT120412	FST3	<input type="radio"/>

### SCGT

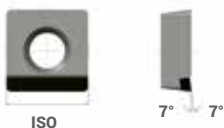

ISO	Edge prep	Uncoated CVD
SCGT09T304	FST9	<input checked="" type="radio"/>
SCGT09T308	FST9	<input type="radio"/>
SCGT09T312	FST9	<input type="radio"/>
SCGT120404	FST12	<input type="radio"/>
SCGT120408	FST12	<input type="radio"/>
SCGT120412	FST12	<input type="radio"/>

On request

# CVD TURNING

## T geometry

### TCGW

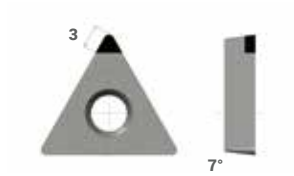

ISO	Edge prep	Uncoated	
		CVD	N
TCGW090202	FST3		<input type="radio"/>
TCGW090204	FST3		<input type="radio"/>
TCGW090208	FST3		<input type="radio"/>
TCGW110202	FST3		<input type="radio"/>
TCGW110204	FST3		<input type="radio"/>
TCGW110208	FST3		<input type="radio"/>
TCGW16T302	FST3		<input type="radio"/>
TCGW16T304	FST3		<input type="radio"/>
TCGW16T308	FST3		<input type="radio"/>
TCGW16T312	FST3		<input type="radio"/>

### TCGW

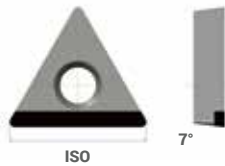

ISO	Edge prep	Uncoated	
		CVD	N
TCGW090202	FST9		<input type="radio"/>
TCGW090204	FST9		<input type="radio"/>
TCGW090208	FST9		<input type="radio"/>
TCGW110202	FST11		<input type="radio"/>
TCGW110204	FST11		<input type="radio"/>
TCGW110208	FST11		<input type="radio"/>
TCGW16T302	FST16		<input type="radio"/>
TCGW16T304	FST16		<input type="radio"/>
TCGW16T308	FST16		<input type="radio"/>
TCGW16T312	FST16		<input type="radio"/>

On request

# CVD TURNING

## T geometry

### TCGT

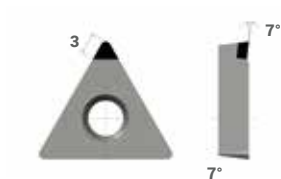

ISO	Edge prep	Uncoated
		CVD
TCGT090202	FST3	<b>N</b>
TCGT090204	FST3	○
TCGT090208	FST3	○
TCGT110202	FST3	○
TCGT110204	FST3	○
TCGT110208	FST3	○
TCGT16T302	FST3	○
TCGT16T304	FST3	○
TCGT16T308	FST3	○
TCGT16T312	FST3	○

### TCGT

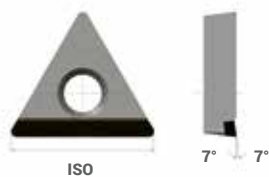

ISO	Edge prep	Uncoated
		CVD
TCGT090202	FST9	○
TCGT090204	FST9	○
TCGT090208	FST9	○
TCGT110202	FST11	○
TCGT110204	FST11	○
TCGT110208	FST11	○
TCGT16T302	FST16	○
TCGT16T304	FST16	○
TCGT16T308	FST16	○
TCGT16T312	FST16	○

On request ○

# CVD TURNING

## V geometry

### VCGW



ISO	Edge prep	Uncoated CVD <b>N</b>
VCGW070201	FST3	<input type="radio"/>
VCGW070202	FST3	<input type="radio"/>
VCGW070204	FST3	<input type="radio"/>
VCGW070208	FST3	<input type="radio"/>
VCGW110301	FST3	<input type="radio"/>
VCGW110302	FST3	<input type="radio"/>
VCGW110304	FST3	<input type="radio"/>
VCGW110308	FST3	<input type="radio"/>
VCGW160401	FST3	<input type="radio"/>
VCGW160402	FST3	<input type="radio"/>
VCGW160404	FST3	<input type="radio"/>
VCGW160408	FST3	<input type="radio"/>
VCGW160412	FST3	<input type="radio"/>

### VCGT

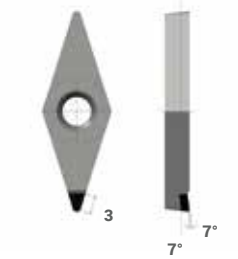

ISO	Edge prep	Uncoated CVD <b>N</b>
VCGT070201	FST3	<input type="radio"/>
VCGT070202	FST3	<input type="radio"/>
VCGT070204	FST3	<input type="radio"/>
VCGT070208	FST3	<input type="radio"/>
VCGT110301	FST3	<input type="radio"/>
VCGT110302	FST3	<input type="radio"/>
VCGT110304	FST3	<input type="radio"/>
VCGT110308	FST3	<input type="radio"/>
VCGT160401	FST3	<input type="radio"/>
VCGT160402	FST3	<input type="radio"/>
VCGT160404	FST3	<input type="radio"/>
VCGT160408	FST3	<input type="radio"/>
VCGT160412	FST3	<input type="radio"/>

On request



A large, light orange, semi-transparent letter 'Q' is centered on the page. The text 'TECHNICAL INFORMATION' is overlaid on the 'Q' in a bold, white, sans-serif font. To the left of the 'Q', there is a vertical rectangular bar of the same light orange color.

# TECHNICAL INFORMATION





# TECHNICAL APPENDIX – CUTTING EDGE TYPE AND CHAMFER ANGLE

The combination of corner radius and cutting edge type has a decisive impact on tool life, surface quality and dimensional accuracy of the component which has to be machined. It is important to choose the most suitable chamfer size and cutting edge type for the given application.

## Types of cutting edges

For our CBN insert range, the following cutting edge types are available:

## Cutting forces Cutting edge stability

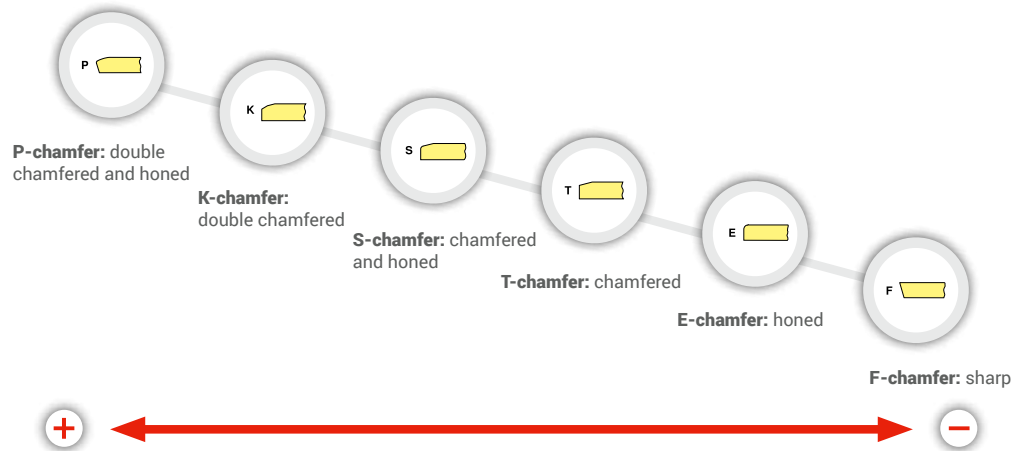

The three most common types are:

### E chamfer

- ▲ Recommended for the finishing of heat-resistant super alloys
- ▲ Feed rate has to be greater than edge hone so that cutting is possible and friction is avoided

### T chamfer

- ▲ The T chamfer is a common geometry recommended for low average chip thickness
- ▲ Preferred choice for cast iron
- ▲ Good alternative to S chamfers for hard turning when reduced cutting forces and close tolerances are required

### S chamfer

- ▲ First choice for hard turning
- ▲ More stable cutting edge than the T chamfer with higher resistance to edge chipping and breakage, meaning a more controllable tool life
- ▲ Ensures constant surface quality
- ▲ Feed rate has to be greater than the edge hone

**Chamfer angle and width**

Generally speaking, the cutting edge stability of a CBN insert increases together with the chamfer angle and width, but the cutting forces and the temperature rise as well. A broad chamfer distributes the cutting forces over a larger area.

This increases the stability of the cutting edge so that higher feed rates become possible. When process stability and consistent tool life are a priority, it is recommended to choose a large chamfer.

When surface quality and dimensional accuracy are the most important factor, a small chamfer provides the best machining results. The cutting forces, temperature and vibration are reduced.

As hard turning is normally a finishing operation, it is necessary to find the optimal cutting edge type. This ensures high-quality components and stable production processes while prolonging tool life.

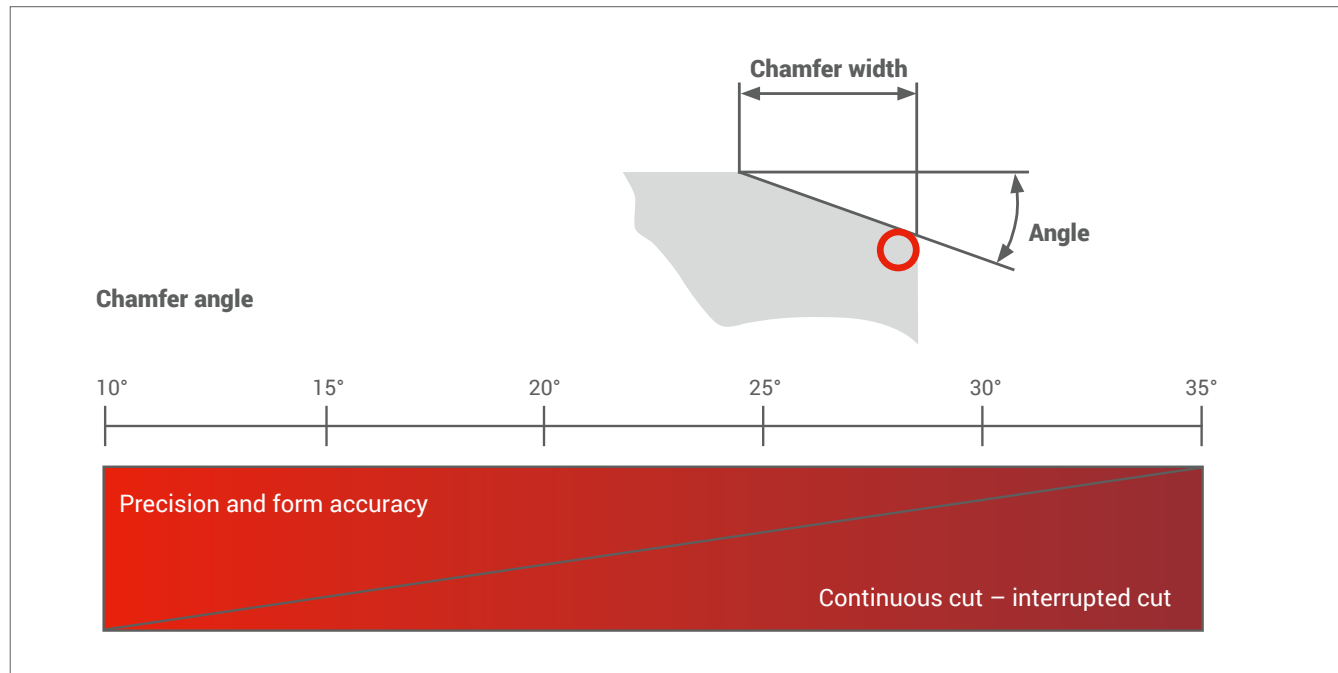

# THEORETICAL SURFACE FINISH

The maximum theoretical surface roughness with turning,  
 $R_{t\text{theor.}}$  is the combination of feed rate and corner radius.

$R_t$  in  $\mu\text{m}$   
 $r_\epsilon$  in mm  
 $f$  in mm/tr

$$R_{t\text{theor.}} = \left( r_\epsilon - \sqrt{r_\epsilon^2 - \frac{f^2}{4}} \right) \cdot 1000 \quad \text{or approximately}$$

$$R_{t\text{theor.}} = \frac{0.125 \cdot f^2}{r_\epsilon}$$

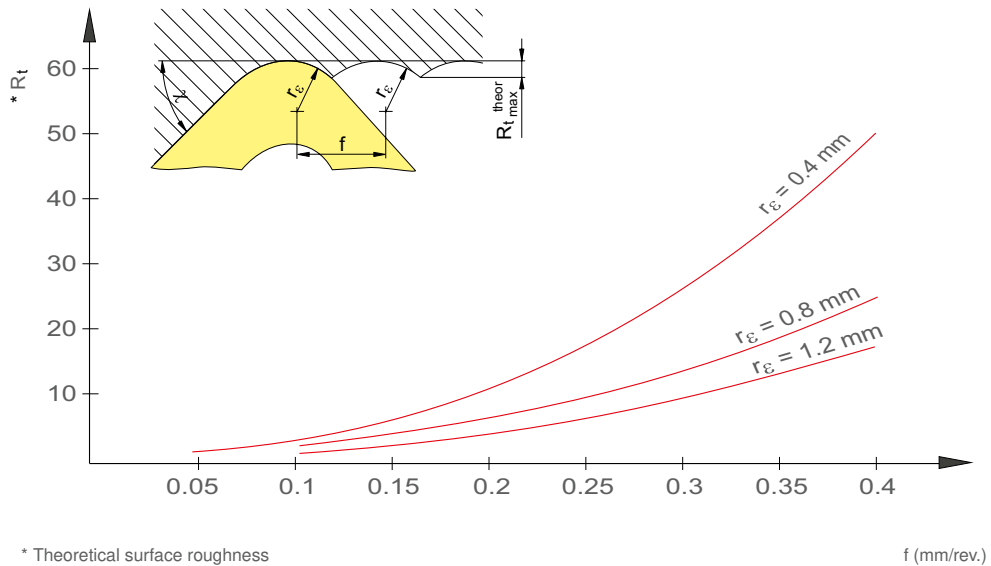

## Cutting data for feed rate

Roughness range $R_z$ in $\mu\text{m}$	$R_{t\text{max}}$	corresponds to $R_a$ -value	Roughness index	ISO 1302	Corner radius $r_\epsilon$ (mm) and feed rate $f$ (mm/rev.)			
					$r_\epsilon = 0.4$	$r_\epsilon = 0.8$	$r_\epsilon = 1.2$	$r_\epsilon = 1.6$
63 – 100	$\sqrt{R_t 100}$	12.5 – 25	N 11	25 $\sqrt{\text{V}}$	–	0.77	0.96	1.11
40 – 63	$\sqrt{R_t 63}$	6.3 – 25	N 10	12.5 $\sqrt{\text{V}}$	0.43	0.62	0.77	0.89
31.5 – 40	$\sqrt{R_t 40}$	4.9 – 6.3	N 9	6.3 $\sqrt{\text{V}}$	0.35	0.50	0.61	0.71
25 – 31.5	$\sqrt{R_t 31.5}$	4.0 – 4.9			0.31	0.44	0.55	0.63
16 – 25	$\sqrt{R_t 25}$	2.5 – 4.0	N 8	3.2 $\sqrt{\text{V}}$	0.28	0.40	0.49	0.56
10 – 16	$\sqrt{R_t 16}$	1.6 – 2.5			0.22	0.32	0.39	0.45
6.3 – 10	$\sqrt{R_t 10}$	1.0 – 1.6	N 7	1.6 $\sqrt{\text{V}}$	0.18	0.25	0.31	0.36

## OPERATING PRINCIPLE / BENEFIT

Improved surface finish with the same feed rate an insert with Wiper cutting edge reaches a roughness value  $R_a$  which is many times higher than the one of a conventional insert.

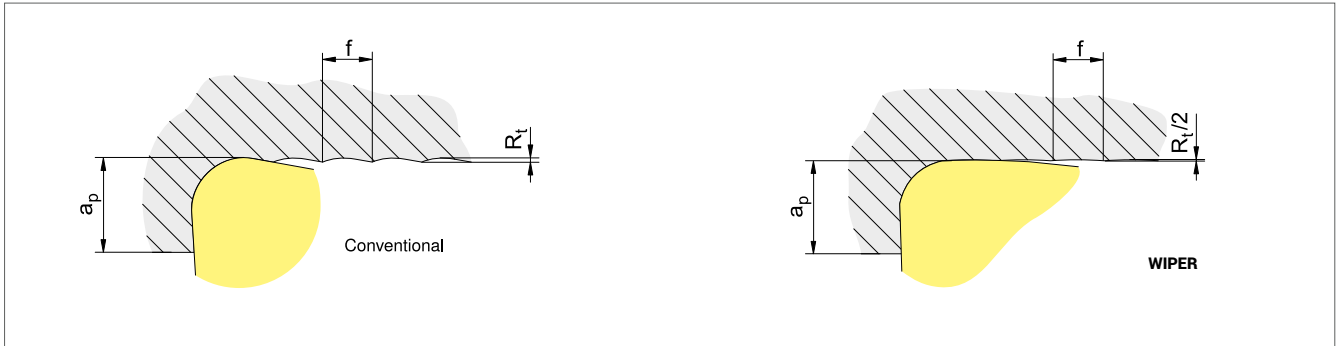

### Shorter machining time

If you want to reach the same  $R_a$ -value as with a standard insert, a twice as high feed rate can be applied for the insert with Wiper cutting edge (= shorter production time per component!).

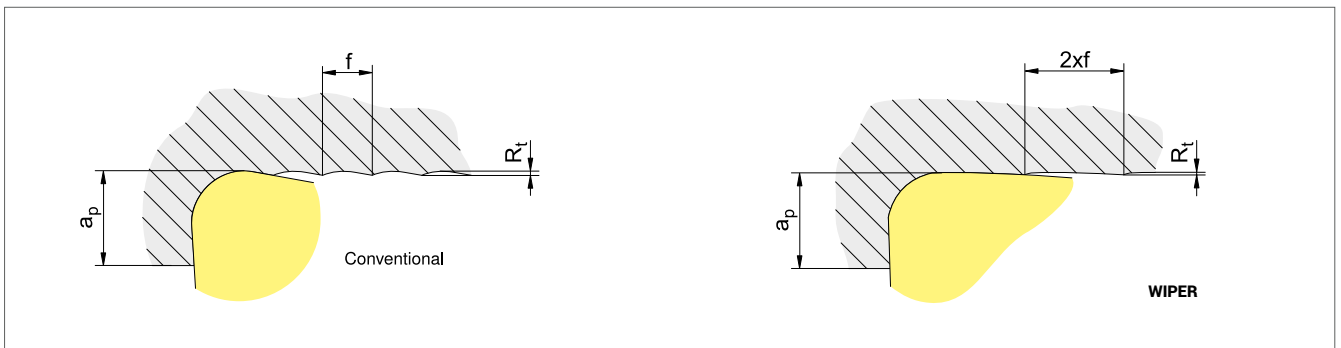



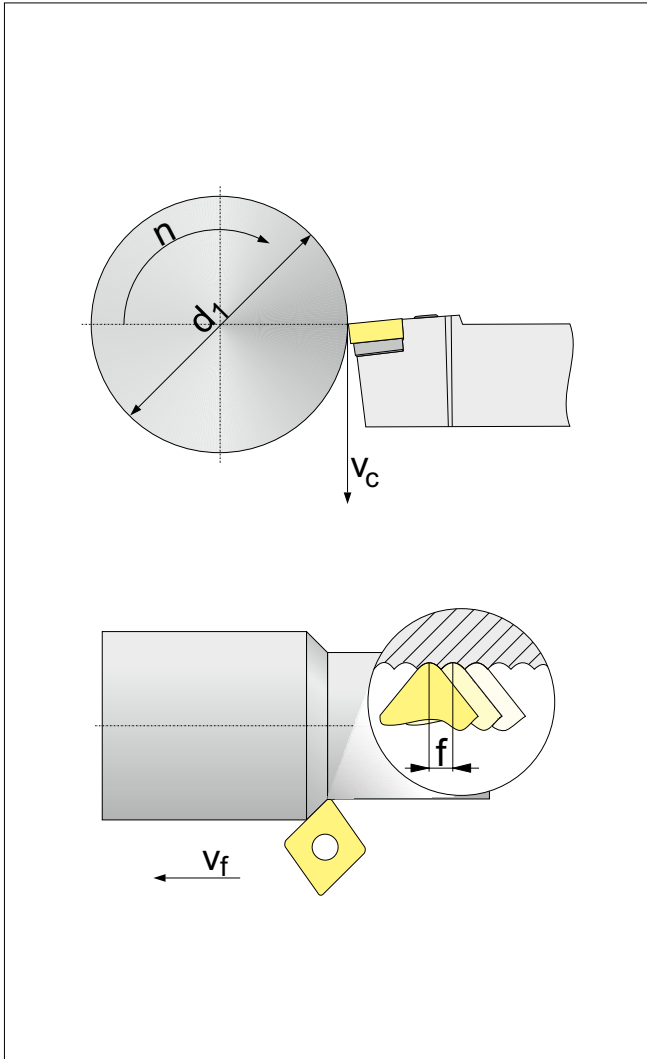

### Cutting speed ( $v_c$ )

$$v_c = \frac{d_1 \cdot \pi \cdot n}{1000} \quad [\text{m/min}]$$

### Revolutions per minute ( $n$ )

$$n = \frac{v_c \cdot 1000}{d_1 \cdot \pi} \quad [\text{rev./min}]$$

### Feed rate ( $v_f$ )

$$v_f = f \cdot n \quad [\text{mm/min}]$$



Type of problem														
Type of wear						Work piece problems				Chip control		Corrective measures		
Flank wear	Cratering	Edge chipping	Plastic deformation	Insert breakage	Built-up edge	Vibration	Formation of pips and burrs	Chattered surface	Surface quality	Chip too long (tangled swarf)	Chip too short (fragmented chip)			
↓					↑	↓			↑	↓		Cutting speed	Cutting values	
≈		↓	↓	↓		↑		↓		↑	↓	Feed rate		
	↓					↓	↓	↓				Feed - centre area		
		↑	≈		↓	≈	↓		↓	↓	↑	Chip groove	Selection of inserts	
↑		↑	↑			↓	↓	↓	↑			Corner radius		↓ larger ↑ smaller
↑	↑	↓	↑	↓								Cutting material		↓ wear resistance ↑ toughness
		≈		≈		≈		≈	≈			Clamping of tool	General criteria	
		≈		≈		≈		≈	≈			Clamping of work piece		
		≈		≈		≈			↓			Overhang		
≈		≈				≈	≈		≈			Tip height		
○	≈		○		○		○		○	○		Cooling lubricant		

raise, increase, large influence  
 raise, increase low influence

avoid, reduce large influence  
 avoid, reduce low influence

≈ check, optimise  
 ○ use



Abrasion on flank, normal wear after a certain machining time.

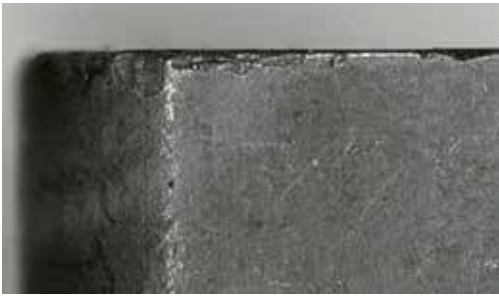

Through excessive mechanical stress at the cutting edge fracture and chipping can occur.



The hot chip which is being evacuated causes cratering at the rake face of the cutting edge.

## Flank wear

### Reasons

- ▲ Cutting speed too high
- ▲ Carbide grade with insufficient wear resistance
- ▲ Incorrect feed rate

### Remedies

- ▲ Reduce cutting speed
- ▲ Select more wear resistant carbide grade
- ▲ Adapt feed rate to cutting speed and cutting depth (increase feed rate)

## Edge chipping

### Reasons

- ▲ Grade with too high wear resistance
- ▲ Vibration
- ▲ Feed rate too high or excessive cutting depth
- ▲ Interrupted cut
- ▲ Swarf damage

### Remedies

- ▲ Use tougher grade
- ▲ Use negative cutting edge geometry with chip groove
- ▲ Increase stability (tool, work piece)

## Cratering

### Reasons

- ▲ Cutting speed and / or feed rate too high
- ▲ Rake angle too shallow
- ▲ Grade with low wear resistance
- ▲ Insufficient coolant supply

### Remedies

- ▲ Reduce cutting speed and / or feed rate
- ▲ Increase coolant quantity and / or pressure, optimise coolant supply
- ▲ Use grade with higher resistance to cratering



High machining temperature and simultaneous mechanical stress can lead to plastic deformation.

## Plastic deformation

### Reasons

- ▲ Too high machining temperature, resulting in softening of substrate
- ▲ Damaged coatings
- ▲ Chip groove too narrow

### Remedies

- ▲ Reduce cutting speed
- ▲ Choose carbide grade with higher wear resistance
- ▲ Provide cooling

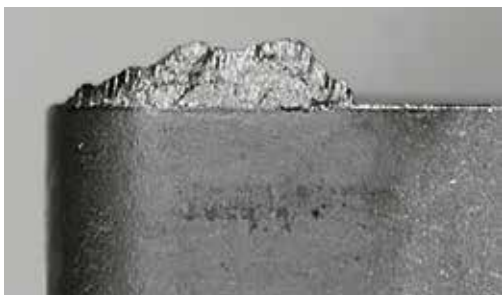

Built-up edge occurs when the chip is not evacuated properly due to insufficient cutting temperature.

## Built-up edge

### Reasons

- ▲ Cutting speed too low
- ▲ Rake angle too small
- ▲ Wrong cutting material
- ▲ Lack of cooling / lubrication

### Remedies

- ▲ Increase cutting speed
- ▲ Increase rake angle
- ▲ Apply TiN-coating
- ▲ Use emulsion with higher concentration



Excessive stress of the insert causes breakage.

## Insert breakage

### Reasons

- ▲ Excessive stress of cutting material
- ▲ Lack of stability
- ▲ Corner angle too small
- ▲ Excessive notching

### Remedies

- ▲ Use tougher cutting material
- ▲ Use protective edge chamfer
- ▲ Increase honing of edge
- ▲ Use more stable geometry



# GRADE OVERVIEW



**PMH10T**

**HT-P15 / HT-M10 / HT-K10**

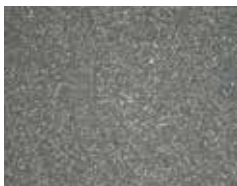

**Specification:**

Composition: cermet Co/Ni 12.2%; WC 15.0%; TaNbC 10.0%; TiCN balance | Hardness: HV<sub>30</sub> 1620

**Recommended application:**

The uncoated cermet grade for the finishing of hardened steel

**P15C**

**HC-P15 / HC-K25 / HC-M10**



**Specification:**

Composition: Co 5.8%; mixed carbides 6.4%; WC balance | Grain size: 1 - 2 μm | Hardness: HV<sub>30</sub> 1550 | Coating specification: CVD TiCN-Al<sub>2</sub>O<sub>3</sub>

**Recommended application:**

The wear-resistant high-performance grade for steel machining

**P25C**

**HC-P25 / HC-K30 / HC-M20**

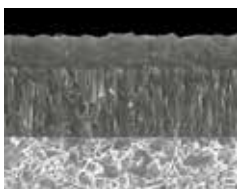

**Specification:**

Composition: Co 7.0%; mixed carbides 8.0%; WC balance | Grain size: 1 - 2 μm | Hardness: HV<sub>30</sub> 1450 | Coating specification: CVD TiCN-Al<sub>2</sub>O<sub>3</sub>

**Recommended application:**

The first choice for the universal machining of steel

**P35C**

**HC-P35 / HC-M25 / HC-S25**

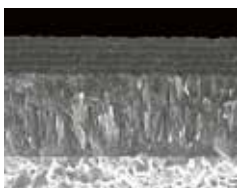

**Specification:**

Composition: Co 9.6%; mixed carbides 6.7%; WC balance | Grain size: 1 - 2 μm | Hardness: HV<sub>30</sub> 1460 | Coating specification: CVD TiCN-Al<sub>2</sub>O<sub>3</sub> multi-layer

**Recommended application:**

The tough alternative for heavily interrupted cutting action

**MK20P**
**HC-M20 / HC-K20**

**Specification:**

Composition: Co 10.5%; mixed carbides 2.0%; WC balance | Grain size: 1-2µm | Hardness: HV<sub>30</sub> 1400 | Coating specification: PVD TiAlTaN

**Recommended application:**

Particularly suitable for the wet machining of steels

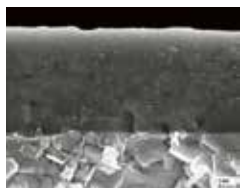
**PMS25P**
**HC-M25 / HC-P35 / HC-S25**

**Specification:**

Composition: Co 9.6%; mixed carbides 7.8%; others 0.4%; WC balance | Grain size: 1 - 2 µm | Hardness: HV<sub>30</sub> 1460 | Coating specification: PVD TiAlTaN

**Recommended application:**

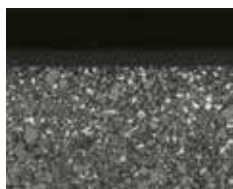
The first choice for the machining of austenitic steels

**MP35P**
**HC-M35 / HC-P35**

**Specification:**

Composition: Co 8.0%; WC balance; mixed carbides 4.2% | Grain size: 1.5 - 3.0 µm | Hardness: HV<sub>30</sub> 1330

**Recommended application:**

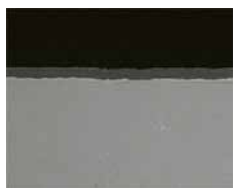
Universal stainless steel turning grade, best grade in difficult conditions

**MS15P**
**HC-M15 / HC-S15**

**Specification:**

Composition: Co 6.0%; WC balance | Grain size: 0.8 - 1,3 µm | Hardness: HV<sub>30</sub> 1630 | Coating specification: PVD TiAlN

**Recommended application:**

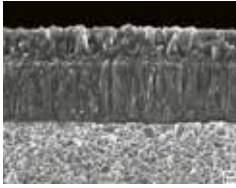
The first choice for the machining of stainless steels and exotic materials

**KP20C****HC-K20 / HC-P10****Specification:**

Composition: Co 6.0%; TaC 2.0%; WC balance | Grain size: 1  $\mu\text{m}$  | Hardness: HV<sub>30</sub> 1630 |  
Coating specification: CVD TiCN-Al<sub>2</sub>O<sub>3</sub>

**Recommended application:**

The first choice for the machining of cast iron at high cutting speeds and where high toughness is required.

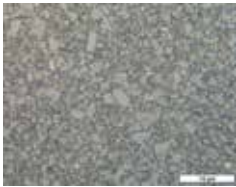
**NK15W****HW-N15 / HW-K15****Specification:**

Composition: Co 6.0%; WC balance | Grain size: 1  $\mu\text{m}$  | Hardness: HV<sub>30</sub> 1630

**Recommended application:**

The uncoated carbide grade for the machining of aluminium and other non-ferrous metals

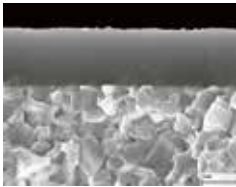
**SM10P****HC-S15 / HC-M15****Specification:**

Composition: Co 6.0%; WC balance | Grain size: 0.8  $\mu\text{m}$  | Hardness: HV<sub>30</sub> 1820 |  
Coating specification: PVD TiAlN

**Recommended application:**

The alternative when machining heat-resistant materials

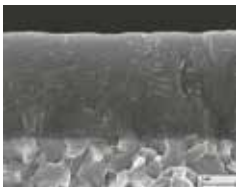
**S15P****HC-S15 / HC-M15****Specification:**

Composition: Co 6.0%; WC balance | Grain size: 0.8  $\mu\text{m}$  | Hardness: HV<sub>30</sub> 1820 |  
Coating specification: PVD TiAlN-TiN

**Recommended application:**

The first choice for the machining of heat-resistant materials



### P25CX

### HC-P25 / HC-K30 / HC-K20

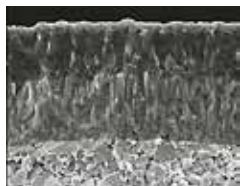

**Specification:**

Composition: Co 7.6%; mixed carbides 7.0%; others 0.4%; WC balance | Grain size: 1-2 $\mu$ m |  
Hardness: HV<sub>30</sub> 1470 | Coating specification: CVD TiCN-Al<sub>2</sub>O<sub>3</sub> top layer

**Recommended application:**

The first and premium choice for the universal machining of steel

### M20CX

### HC-M20 / HC-P30

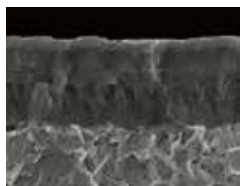

**Specification:**

Composition: Co 7.6%; mixed carbides 7.0%; others 0.4%; WC balance | Grain size: 1-2 $\mu$ m |  
Hardness: HV<sub>30</sub> 1470 | Coating specification: CVD TiCN-Al<sub>2</sub>O<sub>3</sub>-Top layer.

**Recommended application:**

It brings advantages to dry machining, at even higher cutting speeds, and makes long tool life possible.

### K10CX

### HC-K10 / HC-P05

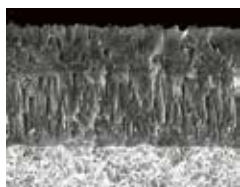

**Specification:**

Composition: Co 5.0%; mixed carbides 2.0%; WC balance | Grain size: submicron |  
Hardness: HV<sub>30</sub> 1810 | Coating specification: CVD TiCN-Al<sub>2</sub>O<sub>3</sub>

**Recommended application:**

The wear-resistant grade for the machining of cast iron at high cutting speed with continuous cut







LSAB Group has long and solid experience of the market's need for cutting tools for the wood and metal industry. We are now broadening our offering with our own brand Miqor Tools and selected products.

[www.miqortools.se](http://www.miqortools.se)