





**FLEXICUT**

**MIQOR**  
tools

# GENERAL OVERVIEW

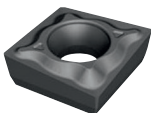
The complete platform from Ø8–32 mm with cutting depths of 1.5xD and 2.25xD

Application	Description	Pages
	XPNX	6
<b>1.5 X D</b> 	Ø 8.00 – 32.00 mm	8
<b>2.25 x D</b> 	Ø 8.00 – 32.00 mm	9
	Spare Parts	11
	Grades	12
	Technical Data	15

# PRODUCTIVITY

## The system:

### 4 machining operations – with just one tool

1. Drilling into solid material with flat bottom holes
2. Boring applications
3. Turning of face profiles
4. External turning applications



### Available in 2 lengths



1.5 x D



2.25 x D

### Multi-purpose tool

Turning and boring  $\varnothing \geq 8$  mm

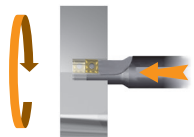

Drilling with flat bottom face

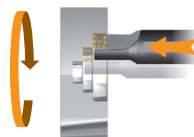

Turning of internal profiles

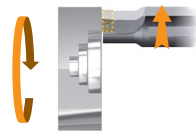

Facing operations



Turning of external profiles

## Your benefits

- Problem solver for insufficient tool storage
- Less programming effort
- Produces a flat bottom hole
- Reduced tool and insert inventory costs
- Considerable tool acquisition cost savings
- Shorter set-up times. Reduced pre-setting time

## Grades for Inserts

- Two coated high-performance grades: U30P & PMS35P. One uncoated: NK15W
- Capable to cover all the ISO material groups P, M, K, N and S

## Tool performances

- Rigid design
- Torx Plus screws for better insert clamping. Easier and more reliable handling
- "Hard & tough" surfaces for easy chip evacuating and reduced surface abrasion

## DESIGNATION SYSTEM FOR INSERTS

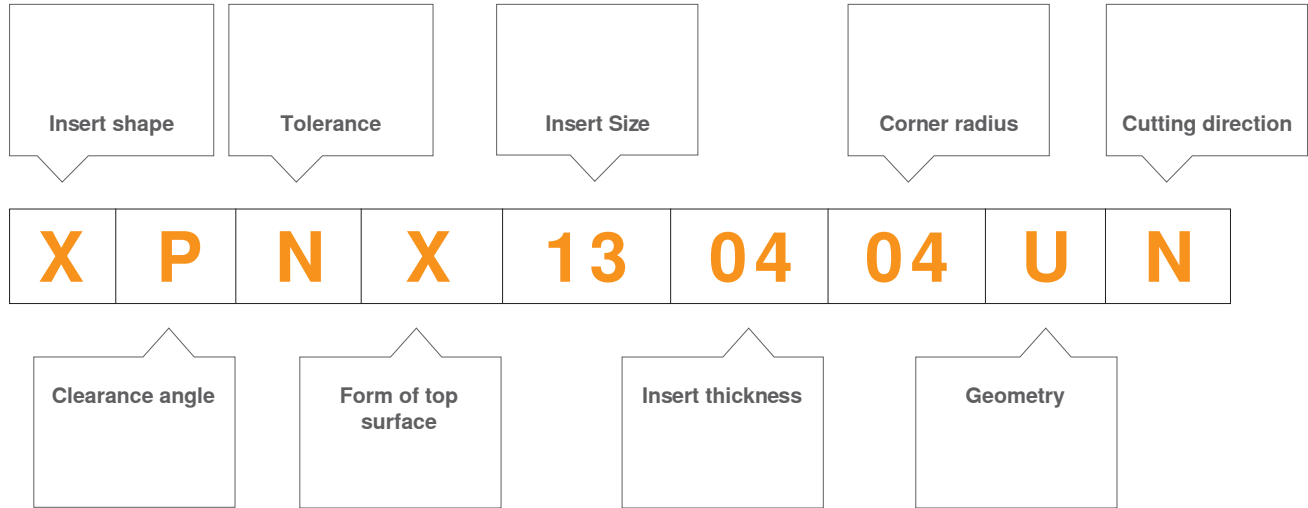

## DESIGNATION SYSTEM FOR HOLDERS



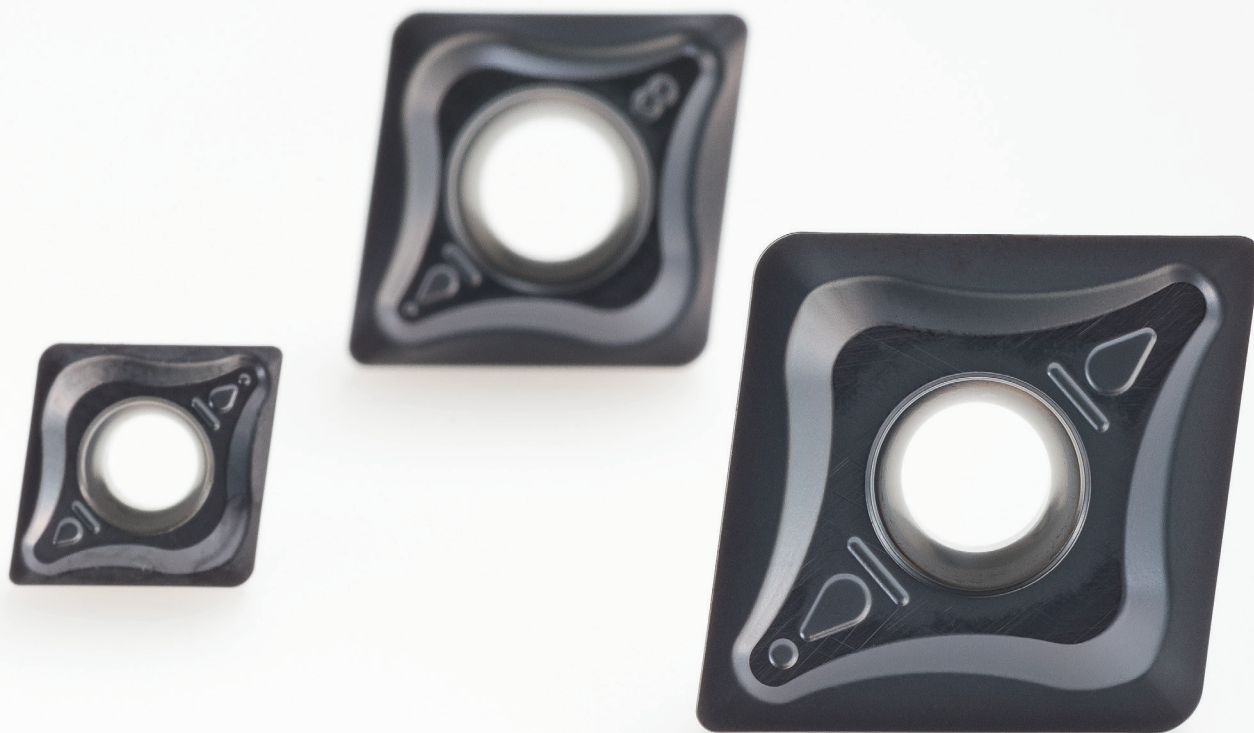

# INSERTS

# XPNX INSERTS

Art.nr.	d [mm]	l [mm]	s [mm]	r [mm]	d <sub>1</sub> [mm]	U30P	PMS35P	NK15W
XPNX040204UL	4.50	4.00	1.80	0.40	2.10	12052485	12052488	
XPNX040204UR	4.50	4.00	1.80	0.40	2.10	12052490	12052492	
XPNX050204UN	5.80	5.00	2.10	0.40	2.25	12052495	12052497	
XPNX060204UN	6.50	6.00	2.92	0.40	2.50	12052498	12052499	
XPNX070304UN	7.60	7.00	3.87	0.40	2.80	12052501	12052503	
XPNX080304UN	8.50	8.00	3.87	0.40	3.40	12131066	12131067	
XPNX090404UN	9.60	9.00	4.66	0.40	3.40	12053144	12053143	
XPNX100404UN	10.60	10.00	4.66	0.40	4.40	12053158	12053146	
XPNX100408UN	10.60	10.00	4.66	0.80	4.40	12053160	12053159	
XPNX130504UN	13.50	12.50	5.45	0.40	5.30	12053165	12053162	
XPNX130508UN	13.50	12.50	5.45	0.80	5.30	12053168	12053166	
XPNX170608UN	17.50	16.00	6.25	0.80	5.30	12053173	12053172	
XPEX050204FN	5.80	5.00	2.10	0.40	2.25			12564629
XPEX060204FN	6.50	6.00	2.92	0.40	2.50			12558732
XPEX070304FN	7.60	7.00	3.87	0.40	2.80			12545420
XPEX080304FN	8.50	8.00	3.87	0.40	3.40			12558731
XPEX090404FN	9.60	9.00	4.66	0.40	3.40			12558729
XPEX100404FN	10.60	10.00	4.66	0.40	4.40			12564630
XPEX130504FN	13.50	12.50	5.45	0.40	5.30			12564631
XPEX170608FN	17.50	16.00	6.25	0.80	5.30			12564633

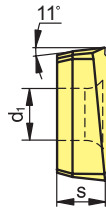
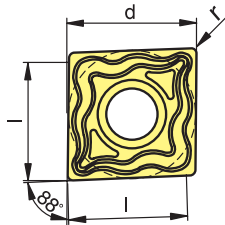

P	●	●	
M	●	●	
K	○		○
N	○		●
S	●	●	○
H			

● 1st choice  
○ 2nd choice

# HOLDERS



# DRILLING DEPTH UP TO 1.5 x D

## Available range

D [mm]	Art.nr.	Material	d <sub>A</sub> [mm]	l <sub>1</sub> [mm]	l <sub>2</sub> [mm]	f [mm]				
8.00	FC08R1.50D04*	12035031	12.00	80.00	12.00	4.00	XP.X 0402	11807484	-	2637804
	FC08L1.50D04*	12035027								
10.00	FC10R1.50D05	12035040	12.00	90.00	15.00	5.00	XP.X 0502	11807480	-	2637804
	FC10L1.50D05	12035034								
12.00	FC12R1.50D06	12035057	16.00	100.00	18.00	6.00	XP.X 0602	11684214	-	2637805
	FC12L1.50D06	12035052								
14.00	FC14R1.50D07	12035065	16.00	110.00	21.00	7.00	XP.X 0703	11684216	2388424	-
	FC14L1.50D07	12160177								
16.00	FC16R1.50D08	12035070	20.00	125.00	24.00	8.00	XP.X 0803	11227305	2269913	-
	FC16L1.50D08	12158340								
18.00	FC18R1.50D09	12035453	25.00	135.00	27.00	9.00	XP.X 0904	11227305	2269913	-
	FC18L1.50D09	12160172								
20.00	FC20R1.50D10	12035456	25.00	150.00	30.00	10.00	XP.X 1004	11610311	2269914	-
	FC20L1.50D10	12160171								
25.00	FC25R1.50D13	12035458	32.00	180.00	37.50	12.50	XP.X 1304	11801441	2388427	-
	FC25L1.50D13	12160170								
32.00	FC32R1.50D17	12035460	40.00	200.00	48.00	16.00	XP.X 1706	11801441	2388427	-
	FC32L1.50D17	12160168								

\* Right-hand holder → Right-hand indexable insert



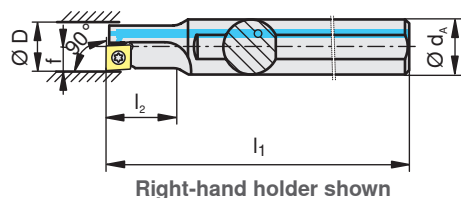

\* Left-hand holder → Left-hand indexable insert





# DRILLING DEPTH UP TO 2.25 x D

## Available range

D [mm]	Art.nr.	Material	d <sub>A</sub> [mm]	d <sub>2</sub> [mm]	l <sub>1</sub> [mm]	l <sub>2</sub> [mm]	l <sub>3</sub> [mm]	f [mm]				
8.00	FC08R2.25D04* FC08L2.25D04*	12035032 12035029	10.00	15.00	60.00	18.00	22.00	4.00	XP.X 0402	11807484	–	2637804
10.00	FC10R2.25D05 FC10L2.25D05	12035047 12035037	12.00	18.00	69.50	22.50	27.50	5.00	XP.X 0502	11807480	–	2637804
12.00	FC12R2.25D06 FC12L2.25D06	12035064 12035054	16.00	22.00	78.00	27.00	33.00	6.00	XP.X 0602	11684214	–	2637805
14.00	FC14R2.25D07 FC14L2.25D07	12035069 12160167	16.00	23.00	83.50	31.50	38.50	7.00	XP.X 0703	11684216	2388424	–
16.00	FC16R2.25D08 FC16L2.25D08	12035076 12160165	20.00	28.00	94.00	36.00	44.00	8.00	XP.X 0803	11227305	2269913	–
18.00	FC18R2.25D09 FC18L2.25D09	12035454 12160164	25.00	36.00	109.50	40.50	53.50	9.00	XP.X 0904	11227305	2269913	–
20.00	FC20R2.25D10 FC20L2.25D10	12035457 12160163	25.00	35.00	111.00	45.00	55.00	10.00	XP.X 1004	11610311	2269914	–
25.00	FC25R2.25D13 FC25L2.25D13	12035459 12160162	32.00	44.00	129.00	56.50	69.00	12.50	XP.X 1304	11801441	2388427	–
32.00	FC32R2.25D17 FC32L2.25D17	12035461 12160157	40.00	54.00	158.00	72.00	88.00	16.00	XP.X 1706	11801441	2388427	–

\* Right-hand holder → Right-hand indexable insert

\* Left-hand holder → Left-hand indexable insert

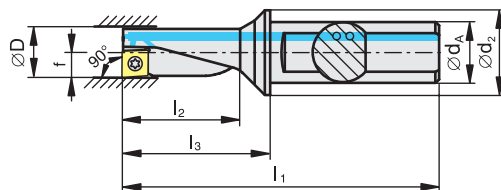

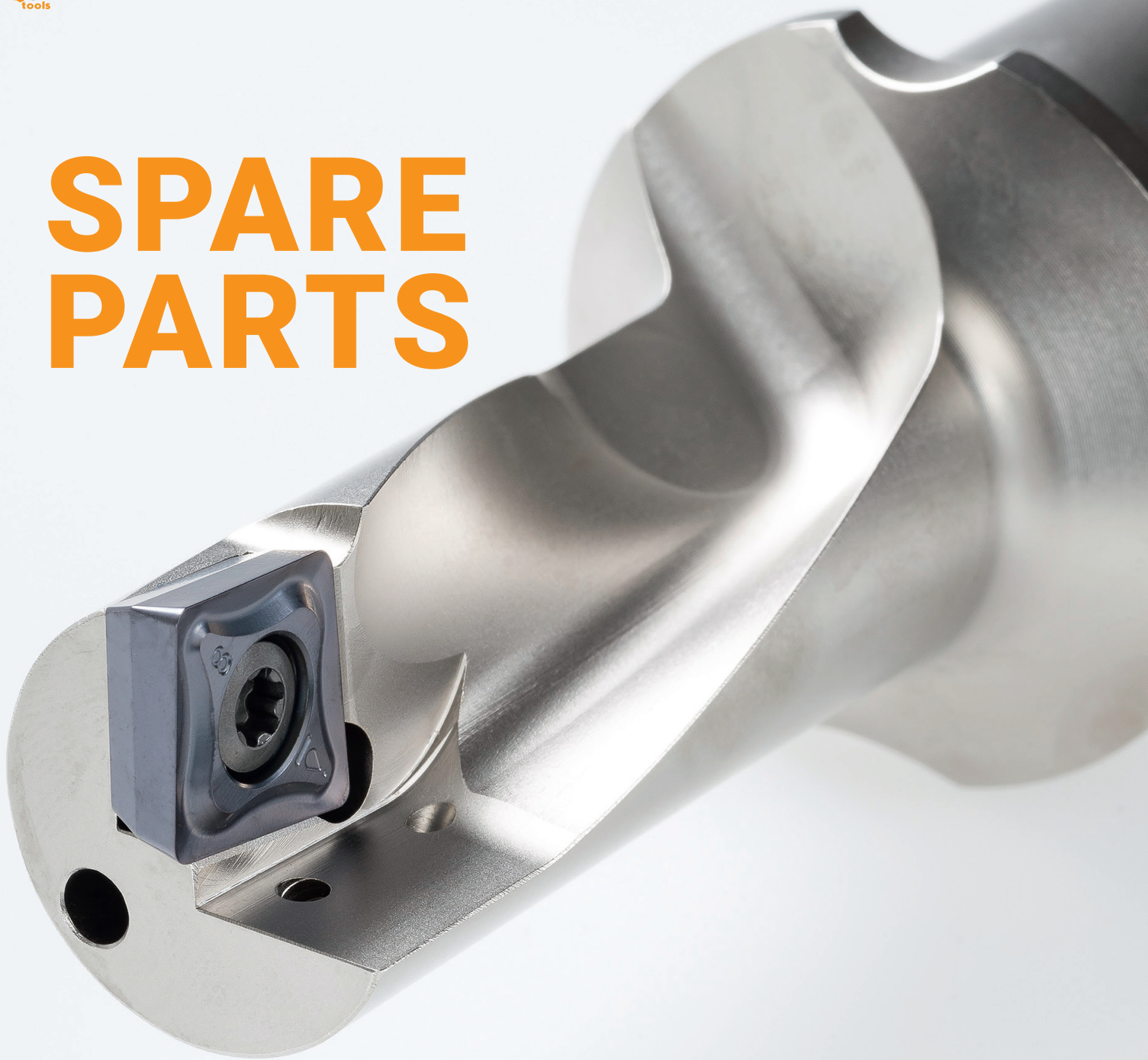

Right-hand holder shown

# SPARE PARTS



# SPARE PARTS

	Material	Art.nr.	Key size
	2637804	F6IP	T06IP
	2637805	F7IP	T07IP
	2388424	DT8IP	T08IP
	2269913	DT9IP	T09IP
	2269914	DT15IP	T15IP
	2388427	DT20IP	T20IP

	Material	Art.nr.	Length [mm]	Thread size	Key size
	11807484	M1.8x3.6-T06IP	3.60	M1.8	T06IP
	11807480	M2.0x4.3-T06IP	4.30	M2.0	T06IP
	11684214	M2.2x5.0-T07IP	5.00	M2.2	T07IP
	11684216	M2.5x6.0-T08IP	6.00	M2.5	T08IP
	11227305	M3.0x7.0-T09IP	7.00	M3.0	T09IP
	11610311	M3.5x8.6-T15IP	8.60	M3.5	T15IP
	11801441	M4.5x10.5-T20IP	10.50	M4.5	T20IP

# GRADES

# GRADE OVERVIEW

Grade	ISO	*Type of coating	Application range													P	M	K	N	S	H				
			01	05	10	15	20	25	30	35	40	45	50	Steel	Stainless steel	Cast iron	Non-ferrous metals	Heat-resistant alloys	Hard materials						
U30P	P30	PVD																•							
	M25	PVD																		•					
	S25	PVD																							•
	K30	PVD																							○
	N25	PVD																							○
PMS35P	P35	PVD																							•
	M30	PVD																							•
	S30	PVD																							•
NK15W	N15	-																							•
	K15	-																							○
	S20	-																							○

# GRADE DESCRIPTION

## U30P

P30 | M25 | S25 | K30 | N25

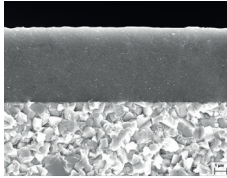

**Specification:**

Composition: Co 9.0%; others 0.75%; WC balance | Grain size: 0.85  $\mu\text{m}$  | Hardness: HV<sub>30</sub> 1590 | Coating specification: PVD TiAlN

**Recommended application:**

The universal high-performance grade for steel, austenitic steel and heat-resistant alloys.

## PMS35P

P35 | M30 | S30

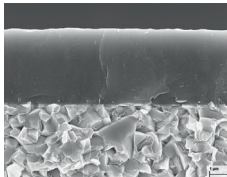

**Specification:**

Composition: Co 10.3%; others 1.2%; WC balance | Grain size: 0.7  $\mu\text{m}$  | Hardness: HV<sub>30</sub> 1600 | Coating specification: PVD TiN / TiAlN

**Recommended application:**

The universal high-performance grade for steel, austenitic steel and heat-resistant alloys.

## NK15W

N15 | K15 | S15

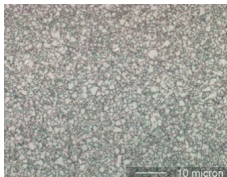

**Specification:**

Composition: Co 6.0%; WC balance | Grain size: 1  $\mu\text{m}$  | Hardness: HV<sub>30</sub> 1630

**Recommended application:**

The uncoated carbide grade for the machining of aluminium. It's an high wear and high resistant carbide with a low tendency to adhesion.



**TECHNICAL  
DATA**

# GRADES / MATERIALS

## Cutting data

Work piece material	Type of treatment / alloy	U30P $v_c$ [m/min]	PMS35P $v_c$ [m/min]	NK15W $v_c$ [m/min]
Steel	Non alloyed steel	50 – 230	70 – 250	–
	Low alloyed steel	50 – 160	60 – 180	–
	High alloyed steel	50 – 150	50 – 160	–
	Corrosion-resistant steel	50 – 180	70 – 180	–
Stainless steel	Stainless steel	50 – 160	90 – 180	–
		–	–	–
		–	–	–
Cast iron	Grey cast iron	90 – 180	–	90 – 180
	Spheroidal cast iron	90 – 180	–	–
	Malleable cast iron	60 – 140	–	–
		–	–	–
Non-ferrous metals	Aluminium wrought alloys	70 – 1800	–	70 – 1800
	Aluminium cast alloys	70 – 1350	–	70 – 1350
	Copper and copper alloys (bronze, brass)	70 – 360	–	70 – 360
	Non-metallic materials	50 – 180	–	50 – 180
Heat-resistant alloys	Heat-resistant alloys	20 – 80	10 – 50	–
	Titanium alloys	30 – 90	30 – 110	40 – 60
		–	–	–
		–	–	–



# DEPTH OF CUT / FEED RATE – 1.5 x D

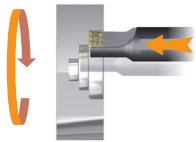

Turning of internal profiles

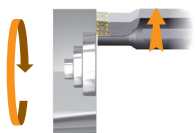
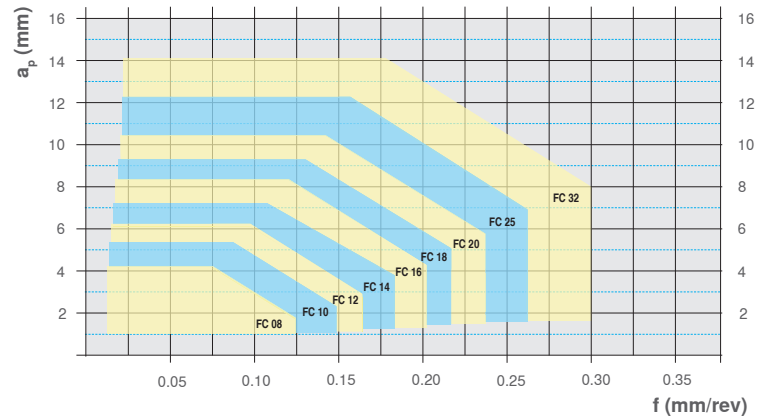

Facing operations

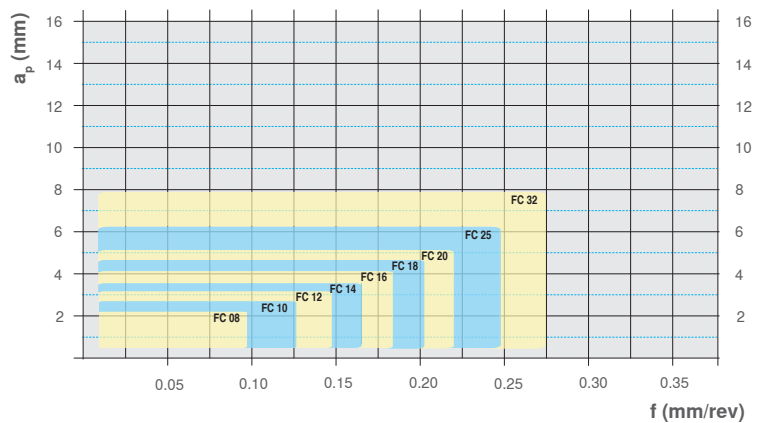

# DEPTH OF CUT / FEED RATE – 2.25 x D

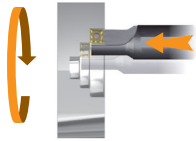

Turning of internal profiles

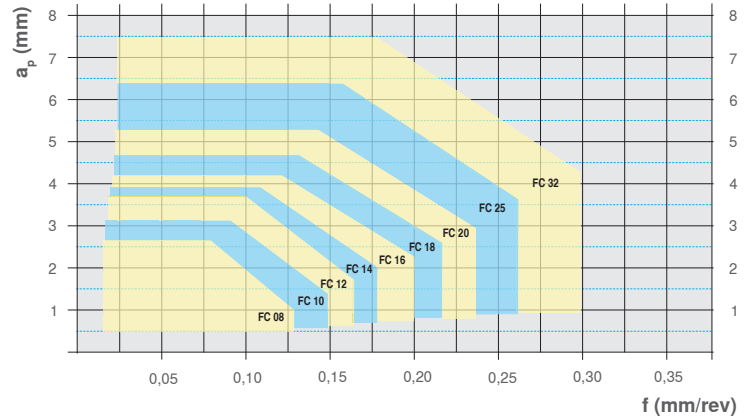

Facing operations

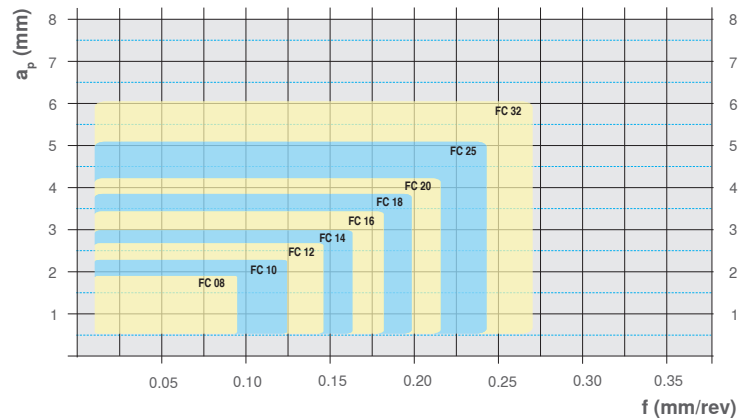

# DRILLING DEPTH / FEED RATE

Drilling depth

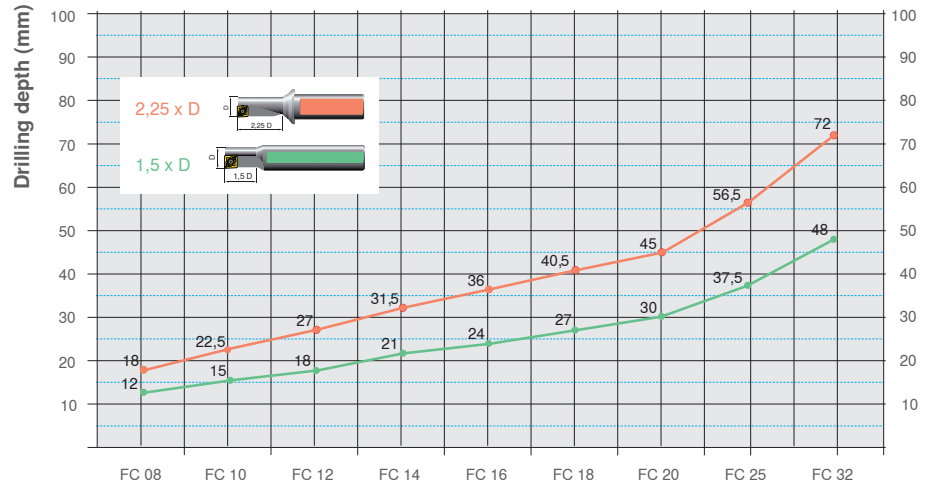

Drilling feed rate

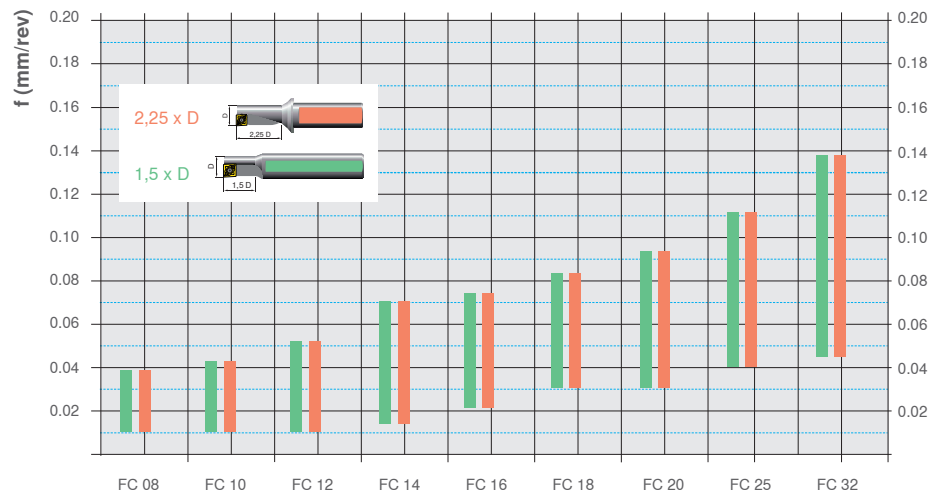

# APPLICATION REFERENCE

## Application

### Axial displacement of the machine

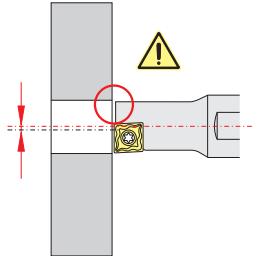

Displacement in x-direction

Correct tool positioning

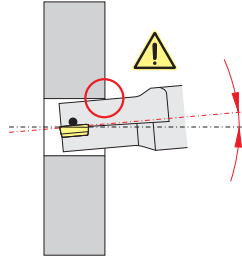

Angular error

Turret and/or spindle adjustment

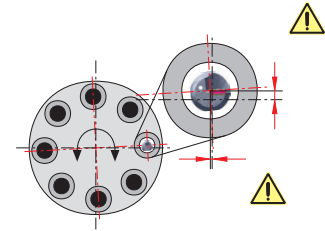

Turret position error

Adjust turret plate (Y-axis)



### Mounting of the insert

For tools  $\varnothing$  8 mm right-hand or left-hand inserts are required. From  $\varnothing$  10-32 mm neutral inserts are applied.

### Through hole

With through holes a **sharp-edged disk** is created as tool break-out occurs. Safety actions are necessary.

# OFF-CENTRE DRILLING

## Application

Type of tool Solid carbide	Nominal tool D [mm]	Work piece bore diameter	
		D <sub>min</sub> [mm]	D <sub>max</sub> [mm]
FC 08 R/L ... 04	8.00	7.85	8.30
FC 10 R/L ... 05	10.00	9.85	10.50
FC 12 R/L ... 06	12.00	11.85	12.50
FC 14 R/L ... 07	14.00	13.85	14.50
FC 16 R/L ... 08	16.00	15.85	16.50
FC 18 R/L ... 09	18.00	17.85	18.50
FC 20 R/L ... 10	20.00	19.80	20.50
FC 25 R/L ... 13	25.00	24.80	25.80
FC 32 R/L ... 17	32.00	31.80	33.00

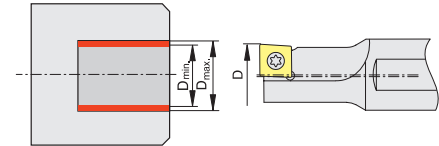

Thanks to the special design of the holder and the indexable inserts Off-centre drilling is possible.

# MACHINING ACROSS CENTRE LINE

## Application

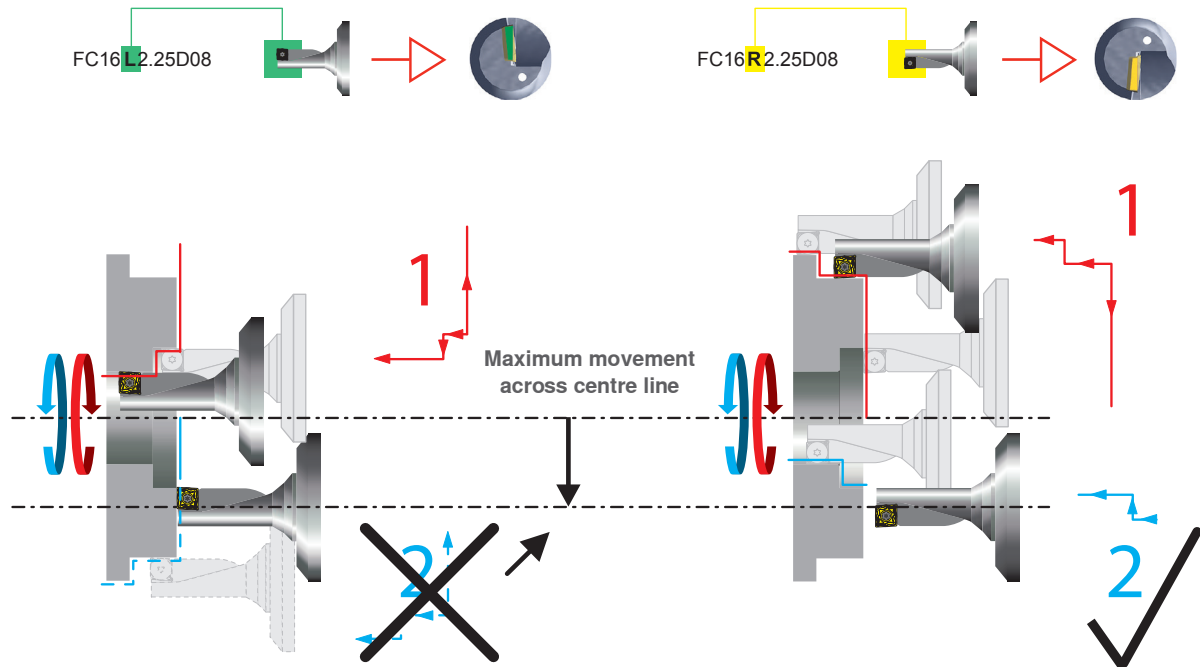

**Situation:**  
In case of insufficient movement of the machine across the centre line the external diameter cannot be machined with the same tool

**Solution:**  
Use a right-hand FlexiCut tool

# CHIP BOOSTER / COOLANT PRESSURE

## Application

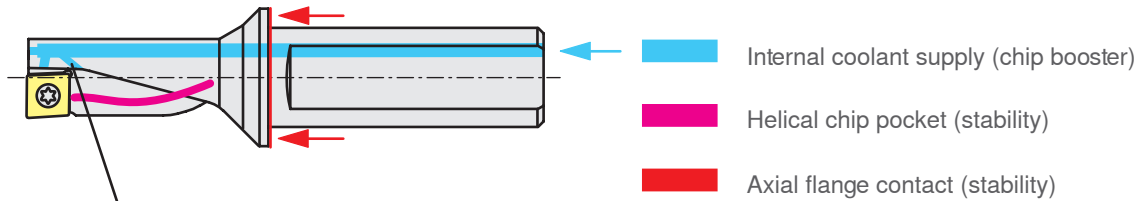

FlexiCut offers an innovative detail solution for range 2.25xD.

An additional backwards directed coolant stream improves chip evacuation from the flute area. A minimum coolant pressure of 1.5 – 3 bar (optimum 5 – 7 bar) is required.



LSAB Group has long and solid experience of the market's need for cutting tools for the wood and metal industry. We are now broadening our offering with our own brand Miqor Tools and selected products.

[www.miqortools.se](http://www.miqortools.se)